



IRIG STANDARD 313-01

RANGE SAFETY GROUP

**TEST STANDARDS FOR FLIGHT
TERMINATION RECEIVERS/DECODERS**

**WHITE SANDS MISSILE RANGE
KWAJALEIN MISSILE RANGE
YUMA PROVING GROUND
DUGWAY PROVING GROUND
ABERDEEN TEST CENTER
NATIONAL TRAINING CENTER**

**ATLANTIC FLEET WEAPONS TRAINING FACILITY
NAVAL AIR WARFARE CENTER WEAPONS DIVISION
NAVAL AIR WARFARE CENTER AIRCRAFT DIVISION
NAVAL UNDERSEA WARFARE CENTER DIVISION NEWPORT
PACIFIC MISSILE RANGE FACILITY
NAVAL UNDERSEA WARFARE CENTER DIVISION, KEYPORT**

**30TH SPACE WING
45TH SPACE WING
AIR FORCE FLIGHT TEST CENTER
AIR ARMAMENT CENTER
AIR WARFARE CENTER
ARNOLD ENGINEERING DEVELOPMENT CENTER
BARRY M. GOLDWATER RANGE
UTAH TEST AND TRAINING RANGE**

NEVADA TEST SITE

**DISTRIBUTION: APPROVED FOR PUBLIC RELEASE;
DISTRIBUTION IS UNLIMITED**

IRIG STANDARD 313-01

**TEST STANDARDS FOR FLIGHT
TERMINATION RECEIVERS/DECODERS**

MAY 2001

Prepared by

**RANGE SAFETY GROUP
Flight Termination System Committee
RANGE COMMANDERS COUNCIL**

Published by

**Secretariat
Range Commanders Council
U.S. Army White Sands Missile Range,
New Mexico 88002-5110**

**THIS DOCUMENT IS AVAILABLE ON THE
RANGE COMMANDERS COUNCIL WEBSITE AT
<http://jcs.mil/jist3>**

PREFACE

This standard contains testing methodology for Range Safety Flight Termination Receivers and Decoders. The test methodology defined here is applicable to all Flight Termination Receivers (FTRs) no matter where they are tested or where they are intended to be flown. This standard replaces Range Commanders Council (RCC) Range Safety Group (RSG) Standard 313-94, Volume 2. Volume 1 of Standard 313-94 was incorporated into RCC Document 319-99, *Flight Termination Systems Commonality Standard* (For Official Use Only).

It is the intent of this standard to provide commonality for testing methodology of FTRs at all Major Range and Test Facility Base (MRTFB) and National Aeronautics and Space Administration (NASA) facilities. Future reference to MRTFB is assumed to include NASA facilities. Compliance with the test requirements in this standard will eliminate confusion of testing requirements between MRTFB facilities.

This standard was prepared by the Flight Termination System Committee of the Range Commanders Council's Range Safety Group. Please direct any questions to:

Secretariat, Range Commanders Council
CSTE-DTC-WS-RCC
100 Headquarters Avenue
White Sands Missile Range, New Mexico 88002-5110

TELEPHONE (505) 678-1107
DSN 258-1107
EMAIL rcc@wsmr.army.mil

TABLE OF CONTENTS

ACRONYMS AND INITIALISMS	ix
--------------------------------	----

SECTION 1 - GENERAL TESTING GUIDELINES.....1

1.1	Introduction.....	1
1.2	Scope.....	1
1.3	General Test Requirements.....	1
1.4	Failure Reporting	2
1.5	Test Equipment	5
1.6	Test Conditions	5
1.7	Standard Test Parameters.....	7
1.8	Standard RCC Tones.....	8
1.9	Secure FTR Tones (Nonstandard RCC Tones).....	8
1.10	Standard Command Logic	8
1.11	Step Sizes	8
1.12	Stable Output	9
1.13	Specified RF Threshold Sensitivity	9
1.14	Measured RF Threshold Sensitivity.....	9
1.15	Test Units/Sequence.....	9

SECTION 2 - FLIGHT TERMINATION RECEIVER/DECODER TESTS10

2.1	FTR Test Matrix	10
2.1	Warm-up Time.....	12
2.2	Telemetry Short Circuit	13
2.3	Output Circuit Protection.....	14
2.4	Abnormal Voltage.....	16
2.5	Overvoltage/Reverse Polarity Protection.....	18
2.6	Resistances	19
2.7	Input Current and Voltage	20
2.8	Power Transfer Switch.....	22
2.9	Power (dc) Cycling	24
2.10	Self -Test.....	25

2.11	Leakage Current.....	27
2.12	Input Impedance /Voltage Standing Wave Ratio (VSWR)	28
2.13	RF Threshold Sensitivity	31
2.14	Output Functions.....	32
2.15	Maximum Usable RF Level.....	33
2.16	RF Level Monitor (SSTO).....	35
2.17	Continuous Wave (CW) Bandwidth	38
2.18	Operational Bandwidth	40
2.19	CW Peak-to-Valley Ratio	42
2.20	Decoder Channel Bandwidth	45
2.21	Decoder Channel Deviation.....	49
2.22	Adjacent Channel Rejection	51
2.23	Image and Spurious Response Rejection.....	53
2.24	Capture Ratio	57
2.25	Amplitude Modulation (AM) Rejection 50% and 100%	60
2.26	Response Time (Standard FTR).....	62
2.27	Output Load Characteristics	63
2.28	Dynamic Stability	65
2.29	Quieting Sensitivity	66
2.30	Out-of-Band Rejection.....	68
2.31	Noise Immunity	69
2.32	Decoder Logic.....	71
2.33	Audio Output	76
2.34	Fail Safe	78
2.35	Tone Drop (Secure FTR)	80
2.36	Tone Balance (Secure FTR).....	81
2.37	Message Timing (Secure FTR).....	83
2.38	DESTRUCT Before ARM (Secure FTR).....	85
2.39	Reset (Secure FTR).....	86
2.40	Memory (Secure FTR).....	87
2.41	Electromagnetic Interference (EMI)/Electromagnetic Compatibility (EMC)	89
	GLOSSARY	90
	INDEX	96

LIST OF FIGURES

<u>Figure No.</u>	<u>Page No.</u>
1-1. Airborne Flight Termination System Failure Report (page 1 of 2).	3
1-1. Airborne Flight Termination System Failure Report (page 2 of 2).	4
1-2. Typical FTR test setup.	6
2-1. Typical signal strength telemetry output (SSTO) monitor curve.....	38
2-2. CW peak-to-valley ratio.....	44
2-3. Decoder deviation.	51
2-4. Capture ratio.....	59

LIST OF TABLES

<u>Table No.</u>	<u>Page No.</u>
1-1 FTR Standard Test Parameters (STP).....	7
1-2 FTR Command Outputs	8
1-3 Increment Levels For Stimulus Signals	9
2-1A FTR Test Matrix (Page 1 of 2)	10
2-1A FTR Test Matrix (Page 2 of 2)	11
2-1B Test Setup For Warm-Up Time	12
2-2 Test Setup For Telemetry Short Circuit.....	13
2-3 Test Setup For Output Circuit Protection	15
2-4 Test Setup For Abnormal Voltage	17
2-5 Test Setup For Overvoltage/Reverse Polarity Protection	18
2-7 Test Setup For Input Current and Voltage	21
2-8 Test Setup For Power Transfer Switch	23
2-9 Test Setup For Power (dc) Cycling.....	24
2-10 Test Setup For Self-Test	26
2-11 Test Setup For Leakage Current	27
2-12A Test Setup For Input Impedance	29
2-12B Test Setup For Voltage Standing Wave Ratio	30
2-13 Test Setup For RF Threshold Sensitivity.....	31
2-14 Test Setup For Output Function.....	33
2-15 Test Setup For Maximum Usable RF Level	34
2-16 Test Setup For RF Level Monitor (SSTO)	36
2-17 Test Setup For Continuous Wave (CW) Bandwidth.....	39
2-18 Test Setup For Operational Bandwidth.....	41
2-19 Test Setup For CW Peak-to-Valley Ratio.....	42
2-20A Test Setup For Standard Decoder Channel Bandwidth	45
2-20B Test Setup For Secure FTR Pilot Tone Bandwidth	47
2-21 Test Setup For Decoder Channel Deviation	50
2-22 Test Setup For Adjacent Channel Rejection.....	52
2-23 Test Setup For Image and Spurious Response Rejection	54
2-24 Test Setup For Capture Ratio.....	57

2-25	Test Setup For AM Rejection 50% And 100%	60
2-26A	Test Setup For Response Time (Standard FTR)	62
2-26B	Command Functions	63
2-27	Test Setup For Output Load Characteristics	64
2.28	Test Setup For Dynamic Stability	66
2-29	Test Setup For Quieting Sensitivity	67
2-30	Test Setup For Out-Of-Band Rejection	68
2-31	Test Setup For Noise Immunity	70
2-32A	Test Setup For Decoder Standard Logic	72
2-32B	Test Setup For Secure Decoder Logic	73
2-32C	Standard Logic Verification Test (Page 1 of 2)	74
2-32C	Standard Logic Verification Test (Page 2 of 2)	75
2-33	Test Setup For Audio Output	76
2-34	Test Setup For Fail Safe	78
2-35	Test Setup For Tone Drop (Secure FTR)	80
2-36	Test Setup For Tone Balance (Secure FTR)	82
2-37	Test Setup For Message Timing (Secure FTR)	83
2-38	Test Setup For DESTRICT Before ARM (Secure FTR)	86
2-39	Test Setup For Reset (Secure FTR)	87
2-40	Test Setup For Memory (Secure FTR)	88

ACRONYMS AND INITIALISMS

AG	audio generator
AGC	automatic gain control
AM	amplitude modulation
ATP	acceptance test procedure
BOB	break-out-box
BW	bandwidth
CW	continuous wave
dB	decibels
dBm	decibels referenced to 1 milliwatt
dc	direct current
EMI	electromagnetic interference
EMC	electromagnetic compatibility
F _o	operating frequency
FFT	fast Fourier transform
FM	frequency modulation
FSN	federal stock number
FTR	flight termination receiver
FTS	flight termination system
IF	intermediate frequency
IRIG	Interrange Instrumentation Group
kHz	kilohertz
log	logarithm
LPF	low pass filter
LRSO	Lead Range Safety Officer
MIC	meets intent certification
MIL STD	military standard
MHz	megahertz
MRTFB	Major Range and Test Facility Base
NASA	National Aeronautics and Space Administration
NBS	National Bureau of Standards
NIST	National Institute of Standards and Technology
OCV	open circuit voltage
OVP	overvoltage protection

QTP	qualification test procedure
RCC	Range Commanders Council
RSG	Range Safety Group
RF	radio frequency
rms	root-mean-square
RUT	receiver under test
SLVT	Standard Logic Verification Test
SSTO	signal strength telemetry output
STP	standard test parameters
UUT	unit under test
μVrms	microvolts root-mean-square
Vdc	volts of direct current
Vrms	volts root-mean-square value
VSWR	voltage standing wave ratio
Vr	voltage reference level

SECTION 1

GENERAL TESTING GUIDELINES

1.1 Introduction

This standard provides the methodology for testing range safety flight termination receivers (FTRs). It will outline the requirements for each test and establish the pass or fail criteria. Since specific missile systems and range requirements vary, the actual FTR design requirements will also vary. The basic electrical design and performance requirements are contained in RCC Document 319-99, *Flight Termination Systems Commonality Standard*. Actual specifications for vehicle-peculiar requirements are outlined in the procurement specification or contract. All three documents must be congruent and must be reviewed for specific pass or fail criteria.

Prior to the start of ANY test, all procedures must be approved by the Lead Range Safety Office (LRSO). This requirement applies regardless of who is performing the test or where the test is being conducted.

1.2 Scope

The requirements of this standard apply to all range safety FTRs. If the procurement specification requires the FTR to have a special or peculiar feature that is not addressed in this standard, that feature must also be tested. The absence of a test methodology in this standard does not infer that the attribute does not need to be tested. Each test design must be approved by the LRSO as to requirements and methodology.

FTRs that contain features not intended for range safety use will also be tested. Any failures or out-of-tolerance conditions of these features will be handled and reported in the same manner as if they were specifically intended for range safety use. For the purpose of this standard, a flight termination receiver/decoder will be referred to as an FTR, a receiver under test (RUT), or a unit under test (UUT). All three references will assume the inclusion of the decoder. The certification procedure and process described in this standard assumes certification, recertification, and reuse to be the same process.

1.3 General Test Requirements

All FTRs will be tested to ensure that they function within performance parameters in all specified environments. Document 319-99, Chapter 8 defines the testing requirements for FTRs. The LRSO must approve any tailoring of document 319-99 testing procedures. The FTR tests fall into these categories:

- Development
- Qualification
- Acceptance

- Certification
- Range Prelaunch (FTR is in the vehicle)
- Recertification
- Others

A definition of each of these tests can be found in the Glossary and in Document 319-99, Chapter 8. The test categories listed above contain requirements for both operational and nonoperational testing. Operational testing requires that the RUT have primary power applied and some clearly defined attributes to be measured and monitored. This standard describes the test methodology for measuring and monitoring those attributes when required by Document 319-99.

1.4 Failure Reporting

The occurrence of any failure during these tests must be reported to the LRSO within five working days. This requirement applies to all testing beginning with, and subsequent to, the start of the formal acceptance test procedure (ATP). Formal ATP in this case refers to tests conducted that demonstrate the acceptability of units for delivery from the vendor. Failure reporting must be accomplished in accordance with document 319-99, Chapter 9. For purposes of this standard, failures can occur in two modes: soft and hard.

1.4.1 Soft Failures. Soft failures result when FTRs fail to meet the specification but operate otherwise. Soft failures that are present or occur during testing do not require the test to be halted. Testing may continue; however, the failure must be reverified and analysis must be done to ensure that the failure was not induced by the test set or setup.

1.4.2 Hard Failures. Hard failures result when the FTR fails to continue to operate, or causes the primary power to exceed its set limits, or causes the test set to fail. Hard failures generally result when a component within the FTR has failed and not just changed value. Hard failures will cause the test to stop. The failure will be reverified, if possible, but care must be given to not cause further damage to the FTR or to the test instrumentation. The test set will be examined in order to determine that it did not cause the failure.

1.4.3 Failure Report. Both soft and hard failures will be reported in writing to the LRSO on the Airborne Flight Termination System Failure Report form shown in Figure 1-1. Locally-generated and computer-generated forms are acceptable as long as the required data are reported completely.

AIRBORNE FLIGHT TERMINATION SYSTEM FAILURE REPORT <i>(For instructions see reverse)</i>		
REPORTING ACTIVITY		
1. REPORT DATE	2. FAILURE DATE	3. ORGANIZATION
ITEM Identification		
4. NOMENCLATURE		5. MODEL
6. PART NUMBER	7. SERIAL NUMBER	8. ITEM <input type="checkbox"/> NEW <input type="checkbox"/> REPAIRED
9. DATE MANUFACTURED	10. FSN	11. SYSTEM REFERENCE
ITEM SOURCE		
12. VENDOR		13. CONTACT NUMBER
DEFECT DESCRIPTION		
14. NEXT HIGHER ASSEMBLY		15. END ITEM
TEST IDENTIFICATION		
16. TEST LOCATION		17. TYPE OF TEST
18. TEST PROCEDURE		
ACTION TAKEN		
19. <input type="checkbox"/> DEFECTIVE ITEM REPAIRED AND RETURNED TO SERVICE <i>(Explain in Remarks)</i>		20. <input type="checkbox"/> DEFECTIVE ITEM DISPOSED <i>(Explain in Remarks)</i>
21. REMARKS/COMMENTS <i>(a. Circumstances prior to failure. b. Description of failure area/mode. c. Action taken.)</i>		
22. TYPE/PRINTED NAME OF PERSON SIGNING	SIGNATURE	PHONE NUMBER

Figure 1-1. Airborne Flight Termination System Failure Report (page 1 of 2).

BLOCK NO.	<i>INSTRUCTIONS</i>
1.	REPORT DATE: Enter date report signed and forwarded.
2.	FAILURE DATE: Enter date failure occurred.
3.	ORGANIZATION Identify organization initiating failure report.
4.	NOMENCLATURE: Enter name of failed component or system.
5.	MODEL: Enter model identification.
6.	PART NUMBER: Enter manufacturer's part number.
7.	SERIAL NUMBER: Enter serial number of item.
8.	ITEM: NEW OR REPAIRED: Check applicable block to indicate if item was previously repaired or overhauled by the manufacturer, or if item was new. Enter date of repair or overhaul if applicable. Date should be obtainable from the serviceable tag or label on the packaging container.
9.	DATE OF MANUFACTURE: Enter date item was manufactured, if available.
10.	FSN: Enter federal stock number.
11.	SYSTEM REFERENCE: Enter item's flight termination system reference , e.g., flight termination receiver "A" or "B," Battery "A" or "B."
12.	VENDOR: Enter name of manufacturer.
13.	CONTRACT NUMBER: Enter contract number obtained from the serviceable tag or label, if possible. This information will assist in follow-up analysis, if required.
14.	NEXT HIGHER ASSEMBLY: Enter the major component or components on which the defective item was installed when other than a major end item, such as a missile.
15.	END ITEM: Enter the associated missile type and serial number, if applicable.
16.	TEST LOCATION: Identify test location, e.g., contractor's plant or launch pad.
17.	TYPE OF TEST: Identify type test , e.g., bench test, RF, or closed loop-test.
18.	TEST PROCEDURE: Identify test procedure by title and number including revision number.
19.	DEFECTIVE ITEM REPAIRED AND RETURNED TO SERVICE: Check this block if the item is repaired locally and indicate under block 21 (Remarks) what malfunction corrective action was taken.
20.	DEFECTIVE ITEM DISPOSED: Check this block if item is scrapped or returned to vendor for malfunction correction. Indicate under block 21 (Remarks) what disposition is made and include identification reference to all associated unsatisfactory and rejection reports.
21.	REMARKS/COMMENTS: Provide description outlining failure area/mode, circumstances prior to failure, and details in conjunction with blocks 19 and 20.
22.	Self-explanatory.

Figure 1-1. Airborne Flight Termination System Failure Report (page 2 of 2).

1.5 Test Equipment

Test instruments used to perform the tests required by this standard will be fully capable of providing the measurement and stimulus ranges. All instruments will provide accuracy to within one-tenth of the tolerances of the measured variable or the provided stimulus. All test instruments used to perform the tests required by this standard will be calibrated prior to usage. The calibrations will be traceable to the National Institute of Standards and Technology (NIST), formerly the National Bureau of Standards (NBS). If the testing is performed at a nonmilitary laboratory, the final test report must include a certificate of conformance that certifies the NIST traceability. A typical FTR test equipment setup is illustrated in Figure 1-2.

All test reports must contain a list of the test instrumentation used to perform the test. The report will include, as a minimum, the following information:

- Name of instrument
- Manufacturer's identification
- Serial number
- Part number or model number
- Recalibration due date

1.6 Test Conditions

All tests required by this standard must be performed under controlled conditions.

1.6.1 Temperature. Unless otherwise specified, all tests will be conducted at high and low temperatures, followed by testing at ambient temperature. Adequate time will be allotted for stabilization prior to testing at each temperature. Refer to Table 2-1A for specific test temperature requirements.

1.6.2 Test Instrumentation Warm-up Time. Prior to the beginning of the test period, the test instrumentation will be allowed a warm-up period appropriate to the prescribed time specified by the manufacturer. Unless otherwise recommended by a particular instrument vendor, the minimum warm-up time will be 2 hours.

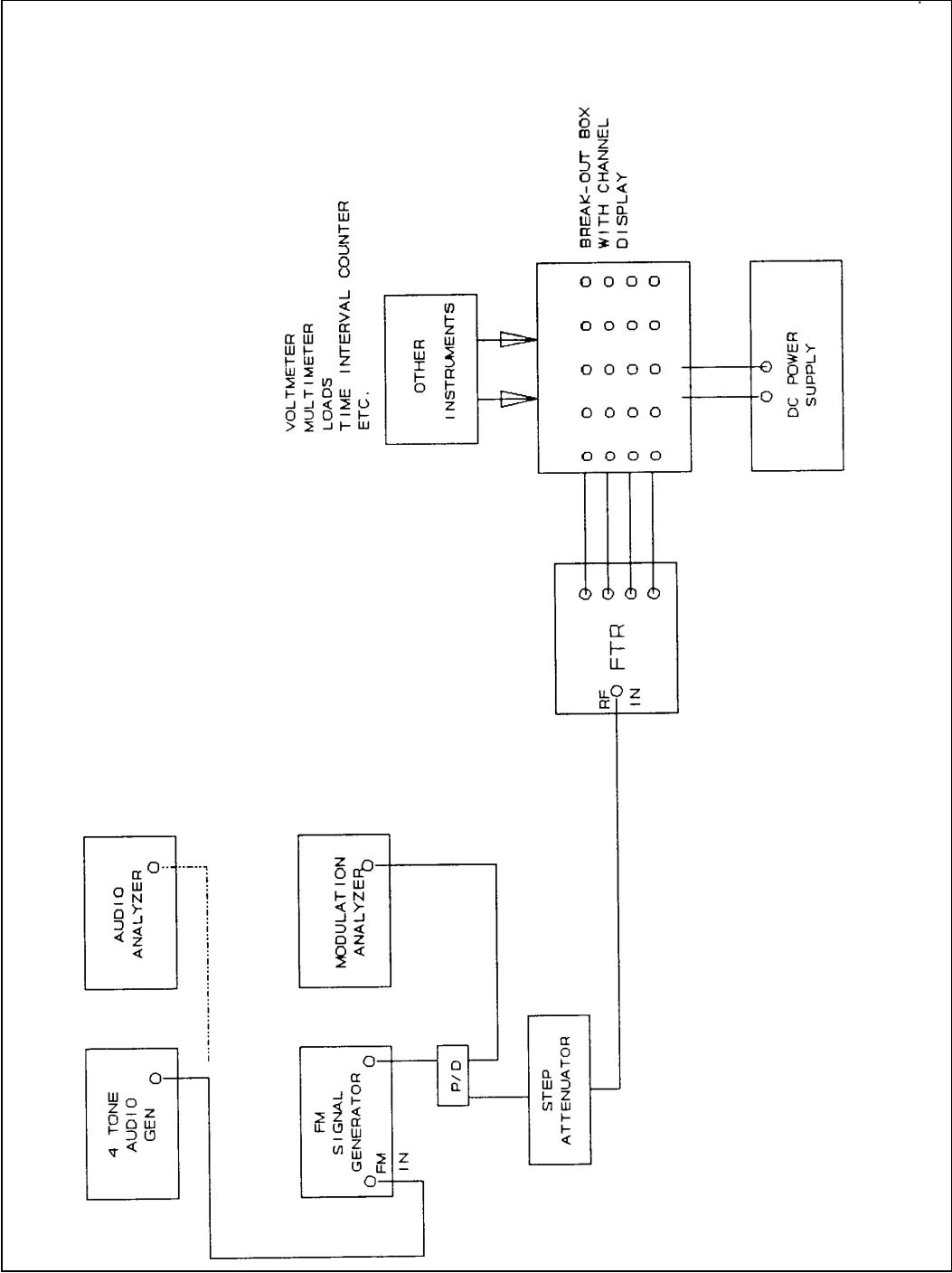

Figure 1-2. Typical FTR test setup.

1.7 Standard Test Parameters

Any standard test parameter (STP) not specified as a test variable for a specific test, will be maintained at its nominal value. The STPs for FTR testing are specified in Table 1-1.

TABLE 1-1. FTR STANDARD TEST PARAMETERS (STP)	
RF center frequency	Assigned ± 0.005 percent
RF input level	Specified minimum RF guaranteed threshold sensitivity level (at the FTR input, NOT the measured threshold sensitivity level). Accuracy of ± 0.5 dB resolution of ± 0.1 dB
Modulation	± 30 kHz ± 1 kHz (per tone)
FTR input dc voltage	Specified nominal ± 0.5 Vdc
FTR input dc current	Current limited to the specified current plus 10 percent (nominal)
RCC tone frequency	± 0.1 percent
Tone distortion	2 percent maximum
Tone balance	± 1 dB (maximum imbalance)
Timing	± 1 millisecond
Temperature	Laboratory ambient
Humidity	Laboratory ambient



All input levels specified in this standard are assumed to mean that level at the *actual input* to the FTR.

1.7.1 All power supplies used to provide test current/voltage to the FTR will provide current limiting and overvoltage protection (OVP) to the FTR.

1.7.2 As a minimum, the dc voltage and current supplied to the FTR will be recorded on test-data sheets prior to each test. Testing organizations are encouraged to continuously record the current and dc voltage supplied to the FTR through the use of devices such as strip chart recorders.

1.7.3 When a test requires that the FTR be tested at dc power supply extremes, the minimum and maximum voltages specified in the procurement specification will be used. If none are specified, the minimum will be 24 Vdc and the maximum will be 32 Vdc.

1.8 Standard RCC Tones

See Table S-1, Standard RCC Tones, in *Supplement to IRIG Standard 313-01, Test Standards for Flight Termination Receivers/Decoders* (For Official Use Only).

1.9 Secure FTR Tones (Nonstandard RCC Tones)

See Table S-2, Secure FTR Tones, in *Supplement to IRIG Standard 313-01, Test Standards for Flight Termination Receivers/Decoders* (For Official Use Only).

1.10 Standard Command Logic

Throughout this document a letter convention (i.e., A, B, C or D) is used to denote the required tones. To determine which tones the letters represent refer to RCC Document 319-99.

Unless otherwise specified and approved by the LRSO, the decoder will not produce a command output under any condition or set of conditions except as indicated in Table 1-2.

TABLE 1-2. FTR COMMAND OUTPUTS	
<u>Logic Sequence</u>	<u>FTR Decoder Output</u>
Tones A and C <u>ON</u>	ARM
Tones A and C <u>ON</u> , followed by tone C <u>OFF</u> , then tone B <u>ON</u> *	ARM and TERMINATE
Tones B and C <u>ON</u>	OPTIONAL
Tone D <u>ON</u>	CHECK CHANNEL
* This is the Standard Sequence logic. The actual sequence of removing tone C and applying tone B will not affect the output; that is, tone B may be applied before or after tone C is removed. All testing, unless otherwise specified, will use the Standard Sequence logic. Tone D may be applied during any of the above sequences without any effect on the desired output.	

1.11 Step Sizes

During certain tests, the type of stimulus signal will be changed according to the increment levels listed in Table 1-3. The incremental adjustments listed under initial measurements will be used until the measurement area is refined, then the refined measurement values will be used.

TABLE 1-3. INCREMENT LEVELS FOR STIMULUS SIGNALS		
<u>Signal Type</u>	<u>Initial Measurements</u>	<u>Refined Measurements</u>
RF Amplitude	1 dB	0.1 dB
RF Frequency	10 kHz	1 kHz
Audio Frequency	10 Hz	1 Hz

1.12 Stable Output

The criteria for determining a stable output of the FTR vary according to type of testing procedure used, as noted in the following:

1.12.1 Manual Operations. A stable output requires no more than five interruptions in the channel output over a one-minute period.

1.12.2 Automatic Operations (Computer Controlled). A stable output requires at least five confirmed outputs with a minimum of 20-millisecond intervals between each confirmed output.

1.13 Specified RF Threshold Sensitivity

The FTR specified RF threshold sensitivity is that minimum RF level specified in the procurement document. This specified level is also known as the *guaranteed threshold sensitivity level*.

1.14 Measured RF Threshold Sensitivity

The FTR measured RF threshold sensitivity is the actual measured RF level where the FTR continues to perform all its required functions.

1.15 Test Units/Sequence

This standard is intended for application to flight instrumentation hardware. All units must be safeguarded to protect against inadvertent damage from physical and electrical elements. Testing that cannot be completed in one test period will be annotated in the test report and other necessary documentation. Any restart of testing will begin with the first step of the last uncompleted test sequence.

SECTION 2

FLIGHT TERMINATION RECEIVER/DECODER TESTS

2.1 FTR Test Matrix

TABLE 2-1A. FTR TEST MATRIX (Page 1 of 2)					
<u>Test No.</u>	<u>Test Name</u>	<u>Test Paragraph</u>	<u>QTP</u>	<u>ATP</u>	<u>Cert/Recert and Reuse</u>
1	Warm-up Time	2.1	T		
2	Telemetry Short Circuit	2.2	T		
3	Output Circuit Protection	2.3	T		
4	Abnormal Voltage	2.4	T		
5	Overvoltage/Reverse Polarity Protection	2.5	T		
6	Resistances (<i>b</i>)	2.6	T	T	T
7	Input Current and Voltage (<i>a</i>)	2.7	T	T	T
8	Power Transfer Switch	2.8	T	T	
9	Power (dc) Cycling	2.9	T	T	
10	Self Test (<i>b</i>)	2.10	T	T	T
11	Leakage Current	2.11	T	T	T
12	Input Impedance (<i>b</i>) VSWR	2.12.1 2.12.2	T T	T T	
13	RF Threshold Sensitivity (<i>a</i>)	2.13	T	T	T
14	Output Functions (<i>a</i>)	2.14	T	T	T
15	Maximum Usable RF Level	2.15	T	T	T
16	RF Level Monitor (SSTO)	2.16	T	T	T
17	CW Bandwidth	2.17	T	T	T
18	Operational Bandwidth (<i>a</i>)	2.18	T	T	T
19	CW Peak-to-Valley Ratio	2.19	T	T	T
20	Decoder Channel Bandwidth (<i>a</i>) Standard Decoder BW Secure Decoder BW (Pilot) Decoder Channel Center Freq.	2.20 2.20.1 2.20.2 2.20.3	T T T T	T T T T	T T T T

TABLE 2-1A. FTR TEST MATRIX (Page 2 of 2)

<u>Test No.</u>	<u>Test Name</u>	<u>Test Paragraph</u>	<u>QTP</u>	<u>ATP</u>	<u>Cert/Recert and Reuse</u>
21	Decoder Channel Deviation (a)	2.21	T	T	T
22	Adjacent Channel Rejection	2.22	T		
23	Image and Spurious Response Rejection	2.23	T	T	T
24	Capture Ratio	2.24	T	T	
25	AM Rejection 50% AM 100% AM	2.25 2.25.3.2 2.25.3.3	T T T	T T	
26	Response Time (Stand. FTR)	2.26	T	T	T
27	Output Load Characteristics	2.27	T	T	
28	Dynamic Stability	2.28	T	T	
29	Quieting Sensitivity	2.29	T		
30	Out-of-Band Rejection	2.30	T		
31	Noise Immunity	2.31	T		
32	Decoder Logic (a) Standard Logic Secure Logic	2.32 2.32.1 2.32.2	T T T	T T T	T T T
33	Audio Output	2.33	T	T	T
34	Fail Safe (a)	2.34	T	T	T
35	Tone Drop (Secure FTR)	2.35	T		
36	Tone Balance (Secure FTR)	2.36	T		
37	Message Timing (Secure FTR)	2.37	T		
38	DESTRUCT Before ARM (Secure FTR)	2.38	T	T	T
39	Reset (Secure FTR)	2.39	T	T	T
40	Memory (Secure FTR)	2.40	T		
41	EMI/EMC (b)	2.41	T		
<p>(a) These tests will be performed during the operating environment tests. (b) These tests are to be conducted at laboratory ambient temperature only. T = Test</p>					



The number of reuses possible will be determined for each program depending on conditions of use.

Test No. 1

2.1 Warm-up Time

2.1.1 Purpose. This test measures the amount of time it takes the FTR to power up and process a command which results in a stable decoder output. Unless the procurement specification contains a time requirement for FTR warm-up, this test is information purposes only.

2.1.2 Requirement. The time required by the FTR to properly respond to a command, after dc power is applied, will be within the applicable component specification (RCC Document 319-99, Chapter 8, subparagraph 8.12.27).

2.1.3 Test.

2.1.3.1 Setup: Connect the unit to the test equipment as shown in Figure 1-2 and Table 2-1B.

TABLE 2-1B. TEST SETUP FOR WARM-UP TIME	
<u>Device</u>	<u>Settings</u>
RF Generator	
Power Output	-47 dBm
Frequency	F _o
Deviation	±30 kHz/tone
Tone Generator	
Tone A	Off
Tone B	Off
Tone C	Off
Tone D	Off
Power Supply	
Voltage	Nominal specified voltage

2.1.3.2 With the FTR dc power source OFF, apply an ARM command to the RF input. Apply dc power to the FTR and measure the time until the decoder outputs an ARM. The time measurement starts when dc power is applied and stops with the decoder ARM output.



If a laboratory-type power supply is used as the source, then a toggle switch must be placed in the positive lead to ensure "instant on." Laboratory power supply rise time cannot be tolerated for this measurement.

2.1.4 Pass/Fail Criteria. The time interval between the application of power to the FTR decoder and the ARM output will be within the procurement specification time for warm-up, or 3 minutes, whichever is less.

2.1.5 Test Equipment Requirements. A time interval measurement instrument with a readout resolution and accuracy of at least one millisecond is required.

Test No. 2

2.2 Telemetry Short Circuit

2.2.1 Purpose. This test verifies that the FTR can process or continue to process a command output when the telemetry outputs are shorted.

2.2.2 Requirement. The FTR will process an ARM and TERMINATE command when the telemetry outputs are short circuited (RCC Document 319-99, Chapter 8, subparagraph 8.12.31).

2.2.3 Test.

2.2.3.1 Setup: Connect the unit to the test equipment as shown in Figure 1-2 and Table 2-2.

TABLE 2-2. TEST SETUP FOR TELEMETRY SHORT CIRCUIT	
<u>Device</u>	<u>Settings</u>
RF Generator	
Power Output	-95 dBm
Frequency	F _o
Deviation	± 30 kHz/tone
Tone Generator	
Tone A	Off
Tone B	Off
Tone C	Off
Tone D	Off
Power Supply	
Voltage	Nominal specified voltage



This may be a destructive test. The shorted telemetry output channel does not have to be operative after the test.

2.2.3.2 Configure the test setup so that the FTR telemetry monitor outputs are accessible.

2.2.3.3 Transmit an ARM command to the FTR.

2.2.3.4 While monitoring the FTR command output, short each telemetry monitor output (i.e., ARM telemetry monitor, TERMINATE telemetry monitor, tone telemetry monitors, SSTO, and other command or signal telemetry monitor outputs) to case ground. Verify that the ARM command output remains ON.

2.2.3.5 Remove the shorts to case ground and apply them to power return. Verify that the ARM command output remains ON.

2.2.3.6 Remove the shorts to power return and repeat 2.2.3.3 through 2.2.3.5 using the TERMINATE command.

2.2.3.7 Remove the shorts and repeat 2.2.3.3 through 2.2.3.5 for all other commands that the FTR is capable of receiving.

2.2.3.8 Perform steps 38 through 44 of the logic test in Table 2-32C.

2.2.4 Pass/Fail Criteria. The shorting of the telemetry monitor outputs will not prevent the FTR from properly decoding the commands and the FTR will function properly during the logic test.

2.2.5 Test Equipment Requirements. The test requires access to the FTR telemetry monitor outputs.

Test No. 3

2.3 Output Circuit Protection

2.3.1 Purpose. This test verifies that the FTR can process or continue to process a command output when the telemetry outputs are shorted to a power source.

2.3.2 Requirement. The FTR will not be damaged by the following conditions:

2.3.2.1 By the application of up to 45 Vdc or the open circuit voltage (OCV) of the power source, whichever is greater, to any of the output monitor ports for up to five minutes (RCC Document 319-99, Chapter 8, subparagraph 8.12.33).

2.3.2.2 When the ARM and OPTIONAL output channels are used for vehicle functions, such as engine shutdown, they will also meet the requirements stated above (RCC Document 319-99, Chapter 8, subparagraph 8.12.33.1).

2.3.2.3 The FTR will meet the requirement stated above in the ON and OFF mode (RCC Document 319-99, Chapter 8, subparagraph 8.12.33.2).

2.3.3 Test.

2.3.3.1 Setup: Connect the unit to the test equipment as shown in Figure 1-2 and Table 2-3.

TABLE 2-3. TEST SETUP FOR OUTPUT CIRCUIT PROTECTION	
<u>Device</u>	<u>Settings</u>
RF Generator	
Power Output	-95 dBm
Frequency	F _o
Deviation	± 30 kHz/tone
Tone Generator	
Tone A	Off
Tone B	Off
Tone C	Off
Tone D	Off
Power Supply	
Voltage	Nominal specified voltage

2.3.3.2 Configure the test setup so that the FTR telemetry monitor outputs are accessible.

2.3.3.3 Transmit an ARM command to the FTR.

2.3.3.4 While monitoring the FTR command output, apply 45 Vdc or the OCV of the power source, whichever is greater, to each telemetry monitor output (i.e. ARM telemetry monitor, TERMINATE telemetry monitor, tone telemetry monitors, SSTO, and other command or signal telemetry monitor outputs) for 5 minutes. Verify that the ARM command output remains ON.

2.3.3.5 Repeat 2.3.3.3 through 2.3.3.4 using the TERMINATE command.

2.3.3.6 Remove the power source and repeat 2.3.3.3 through 2.3.3.4 for all other commands that the FTR is capable of receiving.

2.3.3.7 Turn off the FTR and apply 45 Vdc or the OCV of the power source, whichever is greater, to each telemetry monitor output for five minutes.

2.3.3.8 Remove the external voltage from the outputs and power up the FTR.

2.3.3.9 Perform steps 38 through 44 of the logic test in Table 2-32C.

2.3.4 Pass/Fail Criteria. The application of the voltage to the telemetry monitor outputs with the FTR ON will not prevent the FTR from properly decoding the commands. When the voltage is applied to the telemetry monitor outputs with the FTR OFF the FTR will properly decode the logic test when powered back up.

2.3.5 Test Equipment Requirements. The test requires access to the FTR telemetry monitor outputs and a second power supply capable of producing 45 Vdc or the open circuit voltage of the power source, whichever is greater, to an accuracy of 0.1 Vdc.

Test No. 4

2.4 Abnormal Voltage

2.4.1 Purpose. This test verifies that the FTR can survive voltages outside the guaranteed operating ranges. The most common cause of abnormal voltages to an FTR is from the battery voltage decreasing at the end of its life. Ground power supplies, when turned on or off, also have a period of time when they are outside of the normal operating range of the FTR.

2.4.2 Requirement. The FTR will not suffer damage when subjected to low and varying voltages (RCC Document 319-99, Chapter 8, subparagraphs 8.12.34).

2.4.3 Test.

2.4.3.1 Setup: Connect the unit to the test equipment as shown in Figure 1-2 and Table 2-4.

TABLE 2-4. TEST SETUP FOR ABNORMAL VOLTAGE	
<u>Device</u>	<u>Settings</u>
RF Generator	
Power Output	-95 dBm
Frequency	F _o
Deviation	± 30 kHz/tone
Tone Generator	
Tone A	Off
Tone B	Off
Tone C	Off
Tone D	Off
Power Supply	
Voltage: The voltage will be varied from 0 volts to nominal voltage and back to 0 volts.	

2.4.3.2 Set the dc power supply to 0 Vdc and set an ARM command.

2.4.3.3 Observe the FTR outputs while slowly increasing the power supply dc output voltage from 0 to nominal voltage. Record the voltage when the ARM output turns ON and record any other outputs that appear.

2.4.3.4 Slowly decrease the power supply dc output voltage to 0 volts. Record the voltage when the ARM output turns OFF and record any other outputs that appear.

2.4.3.5 Set the power supply back to nominal dc voltage. Apply all standard logic such as ARM and TERMINATE and verify that the FTR responds properly.

2.4.4 Pass/Fail Criteria.

2.4.4.1 The ARM output will turn ON when the voltage reaches the minimum specified voltage.

2.4.4.2 All outputs except the ARM output will remain OFF during the voltage changes.

2.4.4.3 The FTR will respond properly to the standard logic commands.

2.4.5 Test Equipment Requirements. The dc power supply must have the capability of adjustment from 0 to the nominal specified voltage in minimum step resolutions of 1 V.

Test No. 5

2.5 Overvoltage and Reverse Polarity Protection

2.5.1 Purpose. This test verifies that the FTR will not be damaged by the application of 45 Vdc or the open circuit voltage (OCV) of the power source, whichever is greater. The intent of this test is to ensure that the FTR will not be damaged if the power source supplies a worst-case voltage or the input voltage is reversed.

2.5.2 Requirement. The FTR will not be damaged under the following conditions:

2.5.2.1 The FTR will not be damaged by the application of up to 45 Vdc or OCV of the power source, whichever is greater (RCC Document 319-99, Chapter 8, subparagraph 8.12.45.1).

2.5.2.2 This voltage will be applied in both the normal and reverse polarity modes to the FTR input port for a period not less than five minutes (RCC Document 319-99, Chapter 8, subparagraph 8.12.45.2 and 8.12.5).

2.5.2.3 The FTR will not produce an output or be damaged (RCC Document 319-99, Chapter 8, subparagraph 8.12.45.3).

2.5.3 Test.

2.5.3.1 Setup: Connect the unit to the test equipment as shown in Figure 1-2 and Table 2-5.

TABLE 2-5. TEST SETUP FOR OVERVOLTAGE/REVERSE POLARITY PROTECTION	
<u>Device</u>	<u>Settings</u>
RF Generator	
Power Output	-95 dBm
Frequency	F_o
Deviation	± 30 kHz/tone
Tone Generator	
Tone A	Off
Tone B	Off
Tone C	Off
Tone D	Off
Power Supply	
The voltage will be varied from nominal to 45 volts or the OCV of the power source, whichever is greater.	

2.5.3.2 Adjust the power supply to 45 volts or the OCV of the power source, whichever is greater.

2.5.3.3 Connect the FTR to the power supply with the input leads reversed (negative to positive and positive to negative).

2.5.3.4 Turn the power supply ON and monitor all FTR outputs for any abnormalities. Monitor and annotate the FTR's direct current. Monitor the outputs and current for a minimum of five minutes.

2.5.3.5 Disconnect the power leads and return them to normal (positive to positive and negative to negative).

2.5.3.6 Turn the power supply ON and monitor all FTR outputs for any abnormalities. Monitor and annotate the FTR's direct current. Monitor the outputs and current for a minimum of five minutes.

2.5.3.7 Apply nominal voltage to the FTR and apply all standard logic such as ARM and TERMINATE and verify that the FTR responds properly.

2.5.4 Pass/Fail Criteria. The FTR will respond properly to the standard logic commands when 45 Vdc or OCV is applied in the normal mode. The FTR will not produce any outputs when 45 Vdc or OCV is applied in reverse polarity.

2.5.5 Test Equipment Requirements. The test setup must be capable of reversing the dc power leads to the FTR and the power source must be capable of producing 45 Vdc or the OCV to an accuracy of 0.1 Vdc.

Test No. 6

2.6 Resistances

2.6.1 Purpose. This test verifies that the fabrication process of the FTR did, in fact, provide isolation between various grounds, inputs and outputs, and minimum continuity (grounding) for those circuits that should be connected, such as chassis/case.



Only the measurements that provide meaningful data for FTR health and troubleshooting need be made. The actual measurement list must be approved by the LRSO.

2.6.2 Requirement. The isolation and grounding resistance between case ground and all power leads; between signal outputs and command outputs, including returns; and between power leads

and signal leads, including returns, are within the requirements that are specified in the applicable component specification (RCC Document 319-99, Chapter 8, subparagraph 8.12.1.1).

2.6.3 Test.

2.6.3.1 Setup: Disconnect the unit from the test set (no dc power applied).

2.6.3.2 Using an ohmmeter, measure and record the isolation measurements.



If the FTR connector pins are the test points, pin savers must be used to prevent damage to the pins. If a break-out-box (BOB) assembly is used, it must have been tested previously, and its losses known, and appropriate corrections made to the final data. The use of the BOB is the preferred method because it does assist in the prevention of damage to the FTR connector pins.

2.6.4 Pass/Fail Criteria. The pass/fail criteria for this test must be established at the time of design and will be defined in the test procedure.

2.6.5 Test Equipment Requirements. The ohmmeter must have at least 3 ½ digits of measurement display resolution, a range of at least 0.01 to 10 megaohms, and an absolute worst-case resistance accuracy of 2 percent.

Test No. 7

2.7 Input Current and Voltage

2.7.1 Purpose. This test combines the input current test and the dc voltage test as outlined in RCC Document 319-99. This test verifies that FTR power consumption is within specified limits in standby and commanded modes, and that the FTR functions normally at the specified voltages.

2.7.2 Requirement. The current will not exceed the specified current in standby or in each commanded mode and that the FTR functions normally at the specified voltages (RCC Document 319-99, Chapter 8, subparagraphs 8.12.3 and 8.12.2).

2.7.3 Test.

2.7.3.1 Setup: Connect the unit to the test equipment as shown in Figure 1-2 and Table 2-7.

TABLE 2-7. TEST SETUP FOR INPUT CURRENT AND VOLTAGE	
Device	Settings
RF Generator	
Power Output	Off
Frequency	F_o
Deviation	± 30 kHz/tone
Tone Generator	
Tone A	Off
Tone B	Off
Tone C	Off
Tone D	Off
Power Supply	
Voltage: minimum, nominal, and maximum specified voltages.	



At each step, ensure that the proper command outputs are ON.

2.7.3.2 Terminate the monitor and command outputs into their specified loads and set the input voltage at the minimum specified voltage, measure the input current with no RF input applied (standby) and at nominal voltage.

2.7.3.3 Turn ON the RF generator output and set for -47 dBm.

2.7.3.4 Apply a MONITOR command and measure the input current.

2.7.3.5 Apply an ARM command and measure the input current.

2.7.3.6 Apply a TERMINATE command and measure the input current.

2.7.3.7 Remove the TERMINATE command and apply an OPTIONAL command and measure the input current.

2.7.3.8 Remove the OPTIONAL command and apply a CHECK CHANNEL command and measure the input current.

2.7.3.9 Repeat paragraph 2.7.3.2 through 2.7.3.8 with the input voltage set at the nominal input voltage.

2.7.3.10 Repeat paragraph 2.7.3.2 through 2.7.3.8 with the input voltage set at the maximum input voltage.

2.7.4 Pass/Fail Criteria. The receiver will decode the commands correctly at the various input voltages, and the standby and commanded mode input currents will not exceed the specified values.

2.7.5 Test Equipment Requirements. The dc current meter must have sufficient range and resolution to display the reading with a dc accuracy of two percent or better.

Test No. 8

2.8 Power Transfer Switch

2.8.1 Purpose. This test verifies that the power transfer logic circuits actually operate as specified in the procurement document, that the OFF position is used for external power and that the power source selection will not change as a result of a dropout of the input power source for 50 milliseconds minimum. This test only applies to FTRs that contain power switching circuitry.

2.8.2 Requirement. If a range user has a mandatory need for incorporating power transfer capabilities into an FTR, it must be approved by the LRSO. If approved, the following design requirements apply (RCC Document 319-99, Chapter 3, subparagraph 3.5.9.2.1.8):

2.8.2.1 If an ON/OFF switch is used, the OFF position must be used for external power.

2.8.2.2 The FTR will not change power source selection as a result of an input power source dropout for a period of 50 milliseconds minimum. The current will not exceed the specified current in standby or in each commanded mode and the FTR functions normally at the specified voltages.

2.8.3 Test.

2.8.3.1 Setup: Connect the unit to the test equipment as shown in Figure 1-2 and Table 2-8.

TABLE 2-8. TEST SETUP FOR POWER TRANSFER SWITCH	
<u>Device</u>	<u>Settings</u>
RF Generator	
Power Output	-47 dBm
Frequency	F _o
Deviation	± 30 kHz/tone
Tone Generator	
Tone A	Off
Tone B	Off
Tone C	Off
Tone D	Off
Power Supply	
Voltage	Nominal specified voltage

2.8.3.2 Configure the test setup to only apply the power source input to the FTR on the terminals for **POWER ON** configuration. This configuration should also be the default state. All other testing required to be conducted in accordance with this standard will be in this state.

2.8.3.3 Transmit an ARM and a TERMINATE command to the FTR and verify that the decoder has the correct outputs.

2.8.3.4 Apply the necessary signals to the FTR to cause it to shift its power state to the **POWER OFF** (GROUND) state. Retransmit the ARM and TERMINATE command to the FTR and verify that the outputs remain off.

2.8.3.5 Apply the necessary signals to the FTR to cause it to shift its power state back to the **POWER ON** (FLIGHT) state and retransmit the ARM and TERMINATE commands. Verify that the outputs are present.

2.8.3.6 Interrupt the dc power to the FTR for 50 milliseconds. Verify that the outputs are present.

2.8.3.7 Configure the test setup to apply the dc power to both the **POWER ON** and **OFF** (FLIGHT/GROUND) pins of the FTR.

2.8.3.8 Transmit an ARM and a TERMINATE command to the FTR and verify the decoder outputs.

2.8.3.9 Apply the necessary signal to the FTR to cause it to shift its power state to **POWER OFF/GROUND**. Verify that the outputs are still present and note any interruptions.

2.8.4 Pass/Fail Criteria.

2.8.4.1 In the OFF position, the receiver will only respond if external power is applied.

2.8.4.2 The receiver will remain on the commanded dc power source when subjected to a 50 millisecond input power source dropout.

2.8.5 Test Equipment Requirements. The test set break-out-box must allow access to both the ON and OFF dc power terminals.

Test No. 9

2.9 Power (dc) Cycling

2.9.1 Purpose. This test verifies that the FTR does not degrade or fail after repeated application and removal of primary dc power.

2.9.2 Requirement. The FTR will not be damaged by momentary interruptions in the dc power input (RCC Document 319-99, Chapter 3, subparagraph 3.5.9.2.2.1.22) and any command outputs generated during the application or removal of input power will meet the FTR specification (RCC Document 319-99, Chapter 3, subparagraph 3.5.2.1.4).

2.9.3 Test.

2.9.3.1 Setup: Connect the unit to the test equipment as shown in Figure 1-2 and Table 2-9.

TABLE 2-9. TEST SETUP FOR POWER (dc) CYCLING	
<u>Device</u>	<u>Settings</u>
RF Generator	
Power Output	-47 dBm
Frequency	F _o
Deviation	± 30 kHz/tone
Tone Generator	
Tone A	Off
Tone B	Off
Tone C	Off
Tone D	Off
Power Supply	
Voltage: nominal specified voltage (The power will be interrupted 25 times during the test.)	



The command outputs will be terminated into the load specified in the FTR specification and monitored with a differential oscilloscope or equivalent.

2.9.3.2 Using a momentary switch, break the dc power positive lead at least 25 times. Do not use the power source on/off switch if a conventional laboratory power supply is used. The power source on/off switch is acceptable if the power source is a dc battery.

2.9.3.3 Record the amplitude and pulse width of any transient responses on the command outputs.

2.9.3.4 Apply any additional loads required by the FTR specification and repeat paragraphs 2.9.3.2 and 2.9.3.3 but only break the dc power positive lead two more times for each load.

2.9.3.5 Remove the loads from the command outputs.

2.9.3.6 Transmit all the commands that the FTR is capable of decoding and verify normal outputs.

2.9.4 Pass/Fail Criteria. The FTR will not be damaged by the momentary interruption in dc power. Any transient responses generated will meet the FTR specification for amplitude and pulse width.

2.9.5 Test Equipment Requirements. A differential oscilloscope or equivalent is required to monitor the outputs for transient responses with a voltage resolution of .01 volts and time resolution of 1 μ second.

Test No. 10

2.10 Self -Test

2.10.1 Purpose. This test verifies that the FTR's microprocessor is operating correctly as defined by the built-in self-test diagnostic routines. The failure of self-test will indicate that the FTR microprocessor is either not operating properly or its memory has failed.

2.10.2 Requirement. The FTR microprocessor will be capable of processing a test command routine and issuing a pass/fail output (RCC Document 319-99, Chapter 8, subparagraph 8.12.4.2.1). Additionally, the FTR will not inhibit a command or change command output states during a self-test routine (RCC Document 319-99, Chapter 8, subparagraph 8.12.4.2.2).

2.10.3 Test.

2.10.3.1 Setup. Connect the unit to the test equipment as shown in Figure 1-2 and Table 2-10.

TABLE 2-10. TEST SETUP FOR SELF TEST	
<u>Device</u>	<u>Settings</u>
RF Generator	
Power Output	-47 dBm
Frequency	F _o
Deviation	± 30 kHz/tone
Tone Generator	
Tone A	Off
Tone B	Off
Tone C	Off
Tone D	Off
Power Supply	
Voltage: The voltage will be switched between off and nominal specified voltage.	

2.10.3.1 Apply power to the FTR so that the microprocessor will initiate a power-on self-test. Monitor the test setup for the appropriate output from the FTR that signifies the self-test has been completed and its results are satisfactory.

2.10.3.2 With power applied to the FTR, initiate the SELF-TEST command and monitor the test setup for the appropriate output from the FTR that signifies that the self test has been completed and its results are satisfactory.

2.10.3.3 Reinitiate the SELF-TEST command and then immediately send an ARM command. Monitor the appropriate outputs from the FTR. Verify that the FTR processes the ARM command and that the self-test is completed satisfactorily.

2.10.3.4 Reinitiate the SELF-TEST command and then immediately send an ARM and TERMINATE command. Monitor the appropriate outputs from the FTR. Verify that the FTR processes the ARM and TERMINATE commands and that the self-test is completed satisfactorily.

2.10.3.5 Initiate the ARM and TERMINATE commands and verify that the FTR processes the ARM and TERMINATE commands. While both the ARM and TERMINATE outputs are stable, initiate the SELF-TEST command immediately. Monitor the appropriate outputs from the FTR. Verify that the FTR continues to process the ARM and TERMINATE commands and that the self-test is completed satisfactorily.

2.10.4 Pass/Fail Criteria. The FTR will process the SELF-TEST command properly and the self-test will not prohibit the processing of the ARM and TERMINATE commands or cause the command outputs to change state.

2.10.5 Test Equipment Requirements. No special requirements.

Test No. 11

2.11 Leakage Current

2.11.1 Purpose. This test measures the amount of direct current that the FTR outputs on its command outputs when in the uncommanded state. This measurement is critical to other components that interface with the FTR.

2.11.2 Requirement. The output leakage current will not exceed the value specified in the UUT specification (RCC Document 319-99, Chapter 8, subparagraph 8.12.6).

2.11.3 Test.

2.11.3.1 Setup: Connect the unit to the test equipment as shown in Figure 1-2 and Table 2-11.

TABLE 2-11. TEST SETUP FOR LEAKAGE CURRENT	
<u>Device</u>	<u>Settings</u>
RF Generator	
Power Output	Off and -47 dBm
Frequency	F _o
Deviation	± 30 kHz/tone
Tone Generator	
Tone A	Off
Tone B	Off
Tone C	Off
Tone D	Off
Power Supply	
Voltage	Nominal specified voltage

Using one of two methods, measure the leakage current:

2.11.3.2 Leakage Current Measurement Method One.

2.11.3.2.1 Connect an ammeter between the TERMINATE output and the TERMINATE return terminal. Turn the dc power to the FTR ON and record the ammeter reading.

2.11.3.2.2 Repeat paragraph 2.11.3.2.1 with the ammeter between the different command outputs and their respective returns. Record the ammeter reading for each command output.

2.11.3.2.3 Apply an RF input of -47 dBm and an ARM command with the ammeter between the TERMINATE output and the TERMINATE return terminal. Record the ammeter reading.

2.11.3.3 Leakage Current Measurement Method Two.

2.11.3.3.1 Connect a 100,000 ohm resistor between the TERMINATE output and the TERMINATE return terminal. Turn the dc power to the FTR ON and measure the voltage across the resistor.

2.11.3.3.2 Divide the voltage reading by 100,000 and record the calculated current.

2.11.3.3.3 Repeat paragraphs 2.11.3.3.1 and 2.11.3.3.2 with the resistor between the different command outputs and their respective returns. Record the calculated current for each command output.

2.11.3.3.4 Apply an RF input of -47 dBm and an ARM command with the resistor between the TERMINATE output and the TERMINATE return terminal. Record the calculated current.

2.11.4 Pass/Fail Criteria. The command output leakage currents will not exceed the leakage current requirements of the procurement specification.

2.11.5 Test Equipment Requirements. If a dc ammeter is used, it will have a worst-case resolution of 1 microamps and an accuracy of at least one percent. If a dc voltmeter is used, it will have a worst-case resolution of 1000 microvolts and a dc accuracy of at least one percent. If method two is used, the resistor will have a specified accuracy of ± 1 percent.

Test No. 12

2.12 Input Impedance /Voltage Standing Wave Ratio (VSWR)

2.12.1 Input Impedance.

2.12.1.1 Purpose. This test measures the FTR RF input impedance. An FTR with an out-of-tolerance input impedance will result in a mismatch to the antenna system causing an unnecessary loss of incoming RF energy. This test may be combined with the test in subparagraph 2.12.2.

2.12.1.2 Requirement. The input impedance will be 50 ohms (RCC Document 319-99, Chapter 8, subparagraph 8.12.7).

2.12.1.3 Test.

2.12.1.3.1 Setup: Connect the unit to the test equipment as shown in Figure 1-2 and Table 2-12A.

TABLE 2-12A. TEST SETUP FOR INPUT IMPEDANCE	
<u>Device</u>	<u>Settings</u>
RF Generator	
Power Output	Removed
Frequency	F _o
Deviation	Off
Tone Generator	
Tone A	Off
Tone B	Off
Tone C	Off
Tone D	Off
Power Supply	
Voltage	Nominal specified voltage

2.12.1.3.2 Calibrate the network analyzer and then connect it to the unit RF input connector. Using the operating instructions for the network analyzer, set the output for -20 dBm and measure the impedance. The measured impedance is read directly from the network analyzer display.

2.12.1.4 Pass/Fail Criteria. The measured impedance will be 50 ohms \pm 10 percent.

2.12.1.5 Test Equipment Requirements. Must cover the frequency range from 400 to 500 MHz and have a worst-case RF amplitude measurement accuracy of \pm 2 dB.

2.12.2 Voltage Standing Wave Ratio

2.12.2.1 Purpose. The purpose of this test is to measure the FTR VSWR at the RF input connector. An out-of-tolerance VSWR will result in an inefficient transfer of RF energy from the antenna system to the FTR. This test may be combined with the test in subparagraph 2.12.1.

2.12.2.2 Requirement. The unit RF input VSWR will be 2:1 or less with respect to 50 ohms (RCC Document 319-99, Chapter 8, subparagraph 8.12.7).

2.12.2.3 Test.

2.12.2.3.1 Setup: Connect the unit to the test equipment as shown in Figure 1-2 and Table 2-12B.

TABLE 2-12B. TEST SETUP FOR VOLTAGE STANDING WAVE RATIO	
Device	Settings
RF Generator	
Power Output	Off
Frequency	F _o
Deviation	Off
Tone Generator	
Tone A	Off
Tone B	Off
Tone C	Off
Tone D	Off
Power Supply	
Voltage:	Nominal specified voltage

Using one of the two methods, measure the VSWR:

2.12.2.3.2 VSWR Method One.

2.12.2.3.2.1 Connect a dual directional coupler between the continuous wave (CW) signal generator and the UUT RF input.

2.12.2.3.2.2 Set the signal generator for -20 dBm RF input at the unit.

2.12.2.3.2.3 Use two power meters or a dual power meter (preferred) and measure the forward and reflected power. Subtract the reflected power from the forward power (taking into account any setup and coupler losses). The result is *return loss* (dB).

2.12.2.3.2.4 Convert the return loss dB to VSWR using formulas from an engineering handbook, a look-up table, or determine loss by the following formula:

$$VSWR = \frac{1 + \log^{-1} (dB/20)}{1 - \log^{-1} (dB/20)}$$

2.12.2.3.3 VSWR Method Two.

2.12.2.3.3.1 Set the network analyzer RF output to -20 dBm and connect it to the FTR RF input and measure the VSWR. The VSWR is a fallout of the impedance measurements made by the network analyzer in subparagraph 2.12.1.

2.12.2.4 Pass/Fail Criteria. The measured VSWR will be 2:1 or less.

2.12.2.5 Test Equipment Requirements. The directional coupler and network analyzer must cover the frequency range from 400 to 500 MHz, and the S-parameter measurement inaccuracy must be no greater than ±2 dB.

Test No. 13

2.13 RF Threshold Sensitivity

2.13.1 Purpose. This test verifies that the FTR threshold sensitivity meets the minimum specified in the procurement specification and also falls within the minimum and maximum levels. This test will measure the as-built absolute minimum (lowest possible) RF level where the FTR will continue to properly perform its intended function.

2.13.2 Requirement. The minimum RF signal input level at which the FTR correctly activates the command channels will be as specified in the procurement specification, and will be between -107 dBm to -116 dBm across a 50-ohm impedance (RCC Document 319-99, Chapter 8, subparagraph 8.12.8).

2.13.3 Test.

2.13.3.1 Setup: Connect the unit to the test equipment as shown in Figure 1-2 and Table 2-13.

TABLE 2-13. TEST SETUP FOR RF THRESHOLD SENSITIVITY	
<u>Device</u>	<u>Settings</u>
RF Generator	
Power Output	Varied from -127, in 1-dB increments, to level where command is stable
Frequency	F _o
Deviation	± 30 kHz/tone
Tone Generator	
Tone A	Off
Tone B	Off
Tone C	Off
Tone D	Off
Power Supply	
Voltage: minimum, nominal, and maximum specified	

2.13.3.2 Set the dc power supply to the minimum specified voltage level and the RF signal level to -127 dBm.

2.13.3.3 Apply an ARM command. Slowly increase (decrease the attenuation) the RF signal level until the FTR responds to the ARM command with a stable output. Record the RF level in dBm and the SSTO in volts.

2.13.3.4 Repeat paragraphs 2.13.3.2 and 2.13.3.3 with a TERMINATE command.

2.13.3.5 Repeat paragraph 2.13.3.4 with each of the other commands that the FTR is capable of decoding.

2.13.3.6 Set the dc power supply to the nominal specified voltage level and repeat paragraphs 2.13.3.2 through 2.13.3.5.

2.13.3.7 Set the dc power supply to the maximum specified voltage level and repeat paragraphs 2.13.3.2 through 2.13.3.5.

2.13.4 Pass/Fail Criteria. The FTR measured threshold sensitivity for each command will meet the procurement specification and be between -107 dBm to -116 dBm.

2.13.5 Test Equipment Requirements. The RF generator must have an RF output amplitude that can be varied (from at least -127 to -87 dBm) and with a worst-case resolution of 1 dB and a minimum accuracy of ± 0.5 dB. The dc power source must be adjustable between the minimum and maximum specified levels with a minimum accuracy of ± 0.5 Vdc.

Test No. 14

2.14 Output Functions

2.14.1 Purpose. This test verifies that the FTR can respond to all input tone combinations at the minimum specified RF level.

2.14.2 Requirement. The FTR will respond to all input tone combinations at the minimum specified RF threshold level (RCC 319-99, Chapter 8, subparagraph 8.12.9).

2.14.3 Test.

2.14.3.1 Setup: Connect the unit to the test equipment as shown in Figure 1-2 and Table 2-14.

TABLE 2-14. TEST SETUP FOR OUTPUT FUNCTION	
Device	Settings
RF Generator	
Power Output	The specified threshold sensitivity
Frequency	F _o
Deviation	± 30 kHz/tone
Tone Generator	
Tone A	Off
Tone B	Off
Tone C	Off
Tone D	Off
Power Supply	
Voltage: minimum, nominal, and maximum specified	

2.14.3.2 Terminate all outputs into their specified load and set the dc power supply to the minimum specified voltage level.

2.14.3.3 Set the RF amplitude to the specified threshold sensitivity. Apply each command that the FTR is capable of decoding. Verify that the FTR decodes the commands correctly and has only normal command and monitor outputs (no spurious outputs).

2.14.3.4 Set the dc power supply to the nominal specified voltage level and repeat paragraph 2.14.3.3.

2.14.3.5 Set the dc power supply to the maximum specified voltage level and repeat paragraph 2.14.3.3.

2.14.4 Pass/Fail Criteria. The FTR will process the commands properly and will not have any undesired output, either on a monitor or command output channel when operated into the specified load.

2.14.5 Test Equipment Requirements. All FTR outputs for telemetry monitoring and command outputs must be continuously monitored during this test.

Test No. 15

2.15 Maximum Usable RF Level

2.15.1 Purpose. This test verifies that the FTR can operate during and after being exposed to high levels of RF. A high level for this purpose is +13 dBm (1 Vrms) of RF.

2.15.2 Requirement. The FTR will generate the correct output functions when subjected to variations of the RF signal input level up to a maximum of +13 dBm (RCC 319-99, Chapter 8, subparagraph 8.12.10).

2.15.3 Test.

2.15.3.1 Setup: Connect the unit to the test equipment as shown in Figure 1-2 and Table 2-15.

TABLE 2-15. TEST SETUP FOR MAXIMUM USABLE RF LEVEL	
<u>Device</u>	<u>Settings</u>
RF Generator	
Power Output	+13, -7, -27, -47, -67 dBm and specified threshold sensitivity
Frequency	F_o
Deviation	± 30 kHz/tone
Tone Generator	
Tone A	Off
Tone B	Off
Tone C	Off
Tone D	Off
Power Supply	
Voltage:	Nominal specified voltage

2.15.3.2 Set the RF amplitude to +13 dBm (1 Vrms). Apply each command that the FTR is capable of decoding. Verify that the FTR decodes the commands correctly and has only normal command and monitor outputs (no spurious outputs).

2.15.3.3 Set the RF amplitude to the specified threshold sensitivity. Apply each command that the FTR is capable of decoding. Verify that the FTR decodes the commands correctly and has only normal command and monitor outputs (no spurious outputs).

2.15.3.4 Set the RF amplitude to -7 dBm (100,000 μ Vrms). Apply each command that the FTR is capable of decoding. Verify that the FTR decodes the commands correctly and has only normal command and monitor outputs (no spurious outputs).

2.15.3.5 Set the RF amplitude to -67 dBm (100 μ Vrms). Apply each command that the FTR is capable of decoding. Verify that the FTR decodes the commands correctly and has only normal command and monitor outputs (no spurious outputs).

2.15.3.6 Set the RF amplitude to -27 dBm (10,000 μ Vrms). Apply each command that the FTR is capable of decoding. Verify that the FTR decodes the commands correctly and has only normal command and monitor outputs (no spurious outputs).

2.15.3.7 Set the RF amplitude to -47 dBm (1000 μ Vrms). Apply each command that the FTR is capable of decoding. Verify that the FTR decodes the commands correctly and has only normal command and monitor outputs (no spurious outputs).

2.15.4 Pass/Fail Criteria. The FTR will process the commands properly and will not have any undesired output, either on a monitor or command output channel.

2.15.5 Test Equipment Requirements. All FTR outputs for telemetry monitoring and command outputs must be continuously monitored during this test.

Test No. 16

2.16 RF Level Monitor (SSTO)

2.16.1 Purpose. This test verifies that the signal strength telemetry monitor (SSTO) voltage is monotonic and directly related to the RF carrier signal level. This test also measures, records, and graphs an SSTO curve.

2.16.2 Requirement. When operating into a 10k-ohm load the SSTO will meet the following requirements:

2.16.2.1 The SSTO output level at quiescent (no RF) will be 0.5 ± 0.25 Vdc (RCC Document 319-99, Chapter 8, subparagraph 8.12.11.1).

2.16.2.2 The SSTO measured command threshold sensitivity input condition will be 0.1 Vdc minimum above the quiescent value.

2.16.2.3 The SSTO output level will reach a maximum of 4.50 Vdc with no less than -60 dBm or no more than -50 dBm of RF input (RCC Document 319-99, Chapter 8, subparagraph 2.12.11.3).

2.16.2.4 The shape of the transfer function will not exceed approximately 1.0 Vdc change in voltage for each 13 dB change in RF input signal over the range between threshold and saturation (RCC Document 319-99, Chapter 8, subparagraph 8.12.11.4).

2.16.2.5 The maximum SSTO voltage will not exceed 5 Vdc under all conditions (RCC Document 319-99, Chapter 8, subparagraph 8.12.11.5).

2.16.2.6 The slope of the SSTO voltage will not become negative from measured threshold to +13 dBm (RCC Document 319-99, Chapter 8, subparagraph 8.12.11.6).

2.16.3 Test.

2.16.3.1 Setup: Connect the unit to the test equipment as shown in Figure 1-2 and Table 2-16.

TABLE 2-16. TEST SETUP FOR RF LEVEL MONITOR (SSTO)	
<u>Device</u>	<u>Settings</u>
RF Generator	
Power Output	-120 dBm (increasing to +13dBm)
Frequency	F _o
Deviation	Off
Tone Generator	
Tone A	Off
Tone B	Off
Tone C	Off
Tone D	Off
Power Supply	
Voltage:	Nominal specified voltage

2.16.3.2 Connect the specified load to the FTR SSTO output.

2.16.3.3 Set the RF generator's RF output to OFF; measure and record the *quiescent SSTO output*.

2.16.3.4 Increase the RF generator's RF output in 5 dB steps from -120 dBm to +10 dBm recording the *SSTO output* at each step.

2.16.3.5 Set the RF generator's RF output to the measured terminate threshold sensitivity (subparagraph 2.16.3.3) and record the *SSTO output*.

2.16.3.6 Set the RF generator's RF output to +13 dBm and record the *SSTO output*.

2.16.3.7 Graph the data. The ordinate is proportional, on a linear scale, to the FTR SSTO voltage. The abscissa is proportional, on a logarithmic scale, to the RF input to the FTR. The graph may contain limit lines on both axes.

The graph must contain the following information:

- date the data was taken
- gradient scale labels
- FTR model number
- FTR serial number
- test organization.

See Figure 2-1 for an example of the SSTO graph. Hand and computer-generated forms and graphs are acceptable.

2.16.4 Pass/Fail Criteria. The SSTO output voltage will meet the following requirements:

2.16.4.1 The quiescent (no RF signal) condition will be 0.5 ± 0.25 Vdc.

2.16.4.2 The SSTO at the measured TERMINATE threshold sensitivity will be a minimum of 0.1 Vdc above the quiescent value.

2.16.4.3 The SSTO voltage will be 4.5 Vdc or less at -60 dBm and at least 4.50 Vdc at -50 dBm.

2.16.4.4 The SSTO will not exceed 5 Vdc under all conditions.

2.16.4.5 The slope of the SSTO voltage will not become negative from -107 dBm to +13 dBm and have no more than a 50 millivolt drop after saturation has been reached.

2.16.5 Test Equipment Requirements. The RF signal generator must have an RF amplitude resolution of 1 dB and an accuracy of at least 0.5 dB. The SSTO reading voltmeter must have a minimum resolution of 4½ digits and have an accuracy of at least one percent.

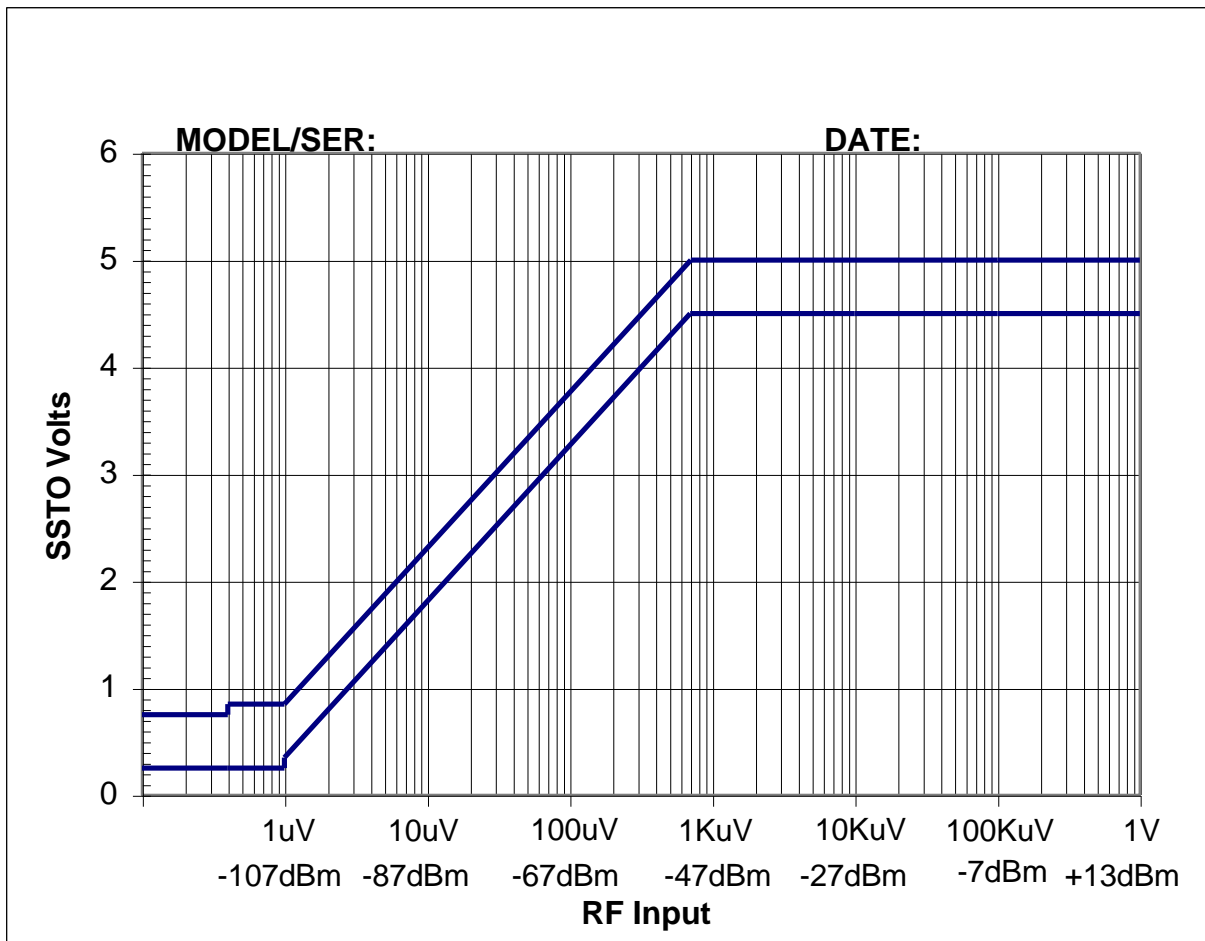

Figure 2-1. Typical signal strength telemetry output (SSTO) monitor curve.

Test No. 17

2.17 Continuous Wave (CW) Bandwidth

2.17.1 Purpose. This test verifies that the FTR's pass band is wide enough to pass the intended signal but is narrow enough to reject unwanted signals and is center on the assigned RF center frequency.

2.17.2 Requirement. The CW bandwidth will be 180 kHz minimum at the 3-dB points and 360 kHz maximum at the 60-dB points (RCC Document 319-99, Chapter 8, subparagraph 8.12.13).

2.17.3 Test.

2.17.3.1 Setup: Connect the unit to the test equipment as shown in Figure 1-2 and Table 2-17.

TABLE 2-17. TEST SETUP FOR CONTINUOUS WAVE (CW) BANDWIDTH	
<u>Device</u>	<u>Settings</u>
RF Generator	
Power Output	Specified minimum threshold sensitivity with 3 and 60 dB output increases
Frequency	F_o varied from center frequency
Deviation	Off
Tone Generator	
Tone A	Off
Tone B	Off
Tone C	Off
Tone D	Off
Power Supply	
Voltage	Nominal specified voltage

2.17.3.2 Set the RF generator to the FTR's specified minimum threshold sensitivity level with the FM modulation OFF. Measure and record the SSTO voltage for reference.

2.17.3.3 Increase the RF generator output 3 dB above the minimum specified threshold level in paragraph 2.17.3.2.

2.17.3.4 Decrease the RF signal generator's RF frequency below the assigned center frequency in kHz steps until the SSTO is equal to or less than the value recorded in paragraph 2.17.3.2. Record this as the *lower 3 dB CW bandwidth frequency*.

2.17.3.5 Increase the RF signal generator's RF frequency above the assigned center frequency in 1 kHz steps until the SSTO is equal to or less than the value recorded in paragraph 2.17.3.2. Record the RF signal generator's frequency as the *upper 3 dB CW bandwidth frequency*.

2.17.3.6 Return the RF signal generator's frequency to the center frequency and increase the output to 60 dB above the minimum threshold sensitivity level in paragraph 2.17.3.2.

2.17.3.7 Repeat paragraph 2.17.3.4 and record the *lower 60 dB CW bandwidth frequency*.

2.17.3.8 Repeat paragraph 2.17.3.5 and record the *upper 60 dB CW bandwidth frequency*.

2.17.3.9 Calculate the *3 dB bandwidth center frequency* by subtracting the lower 3 dB CW bandwidth frequency from the upper 3 dB CW bandwidth frequency, divide the difference by two and add the quotient to the lower 3 dB CW bandwidth frequency.

2.17.3.10 Calculate the 3 dB percent from center frequency by subtracting the calculated 3 dB bandwidth center frequency from the assigned center frequency, divide the difference by the assigned center frequency and multiply the quotient by a hundred. Record the *calculated 3 dB percent*.

2.17.3.11 Repeat paragraphs 2.17.3.9 and 2.17.3.10 using the 60 dB frequencies. Record the *calculated 60 dB percent*.

2.17.4 Pass/Fail Criteria. The FTR's measured CW bandwidth will be at least ± 90 kHz at the 3dB bandwidth and no greater than ± 180 kHz at the 60 dB bandwidth. The calculated center frequency of the 3 dB and 60 dB bandwidths will be within $\pm 0.005\%$ of the assigned center frequency.

2.17.5 Test Equipment Requirements. The RF signal generator output must be variable in RF amplitude in 0.1 dB increments with at least 0.5 dB accuracy, and RF frequency in 1 kHz increments with at least 100 Hz accuracy. The voltmeter used to measure the SSTO must be at least 4½ digits and have a minimum accuracy of one percent.

Test No. 18

2.18 Operational Bandwidth

2.18.1 Purpose. This test verifies that the FTR is capable of properly operating across a specified bandwidth. The operational bandwidth requirements are a direct result of instability in the FTR local oscillator, predetection instability, command transmitter instabilities, and Doppler effects of the RF uplink.

2.18.2 Requirement. The FTR will properly function at all of the commands within the bandwidth of ± 45 kHz from the assigned RF center frequency when subjected to command tones having deviations of ± 30 kHz ± 3 kHz peak per tone (RCC Document 319-99, Chapter 8, subparagraph 8.12.15.1).

2.18.3 Test.

2.18.3.1 Setup: Connect the unit to the test equipment as shown in Figure 1-2 and Table 2-18.

TABLE 2-18. TEST SETUP FOR OPERATIONAL BANDWIDTH	
<u>Device</u>	<u>Settings</u>
RF Generator	
Power Output	Specified minimum threshold sensitivity level
Frequency	F _o varied at least ±45 kHz from center frequency
Deviation	± 30 kHz/tone
Tone Generator	
Tone A	Off
Tone B	Off
Tone C	Off
Tone D	Off
Power Supply	
Voltage	Nominal specified voltage

2.18.3.2 With the RF generator set to the FTR's specified minimum threshold sensitivity level, apply an ARM command.

2.18.3.3 Decrease the RF signal generator RF frequency below the assigned center frequency in 1 kHz increments until the command is lost. Increase the RF frequency in 1 kHz increments until the command is again decoded and stable. Record this as the *lower operation bandwidth frequency for the ARM command*.

2.18.3.4 Increase the RF signal generator RF frequency above the assigned center frequency in 1 kHz increments until the command is lost. Decrease the RF frequency in 1 kHz increments until the command is again decoded and stable. Record this as the *upper operation bandwidth frequency for the ARM command*.

2.18.3.5 Repeat subparagraphs 2.18.3.1 through 2.18.3.4 for each additional command that the FTR is capable of decoding, such as MONITOR, TERMINATE, OPTIONAL, and CHECK CHANNEL. Record the upper and lower operation bandwidth frequencies for each command.

2.18.4 Pass/Fail Criteria. All commands will have a minimum operational bandwidth of ± 45 kHz.

2.18.5 Test Equipment Requirements. The RF signal generator output must be variable in RF amplitude in 0.1 dB increments with at least 0.5 dB accuracy, and RF frequency in 1 kHz increments with at least 100 Hz accuracy.

Test No. 19

2.19 CW Peak-to-Valley Ratio

2.19.1 Purpose. This test measures and verifies that the flatness of the intermediate frequency (IF) filter assembly is as specified.

2.19.2 Requirement. The intermediate frequency (IF) filter flatness will be within 3 dB when it is subjected to an RF input signal within ± 45 kHz of the center frequency (RCC Document 319-99, Chapter 8, subparagraph 8.12.15.2).

2.19.3 Test.

2.19.3.1 Setup: Connect the unit to the test equipment as shown in Figure 1-2 and Table 2-19.

TABLE 2-19. TEST SETUP FOR CW PEAK-to-VALLEY	
<u>Device</u>	<u>Settings</u>
RF Generator	
Power Output	Specified minimum threshold sensitivity level (varied above and below)
Frequency	F_o varied from center frequency
Deviation	Off
Tone Generator	
Tone A	Off
Tone B	Off
Tone C	Off
Tone D	Off
Power Supply	
Voltage	Nominal specified voltage

2.19.3.2 Set the RF generator to the FTR's specified minimum threshold sensitivity level with the FM modulation OFF. Measure and record the SSTO voltage for reference.

2.19.3.3 Set the RF signal generator's RF frequency to 45 kHz below the assigned center frequency.

2.19.3.4 Increase the RF signal generator's RF frequency in 1 kHz steps to at least 45 kHz above the assigned center frequency. Record the *maximum* and *minimum SSTO voltages* during the steps.

2.19.3.5 Set the RF generator's RF frequency back to the assigned center frequency and vary the RF generator's signal level output until the SSTO voltage is equal to the minimum recorded SSTO voltage. Record the RF generator's signal level output as the *lower peak-to-valley RF output*.

2.19.3.6 Repeat paragraph 2.19.3.5 until the maximum recorded SSTO voltage is obtained. Record the RF generator's signal level output as the *upper peak-to-valley RF output*.

2.19.3.7 Calculate the peak-to-valley ratio in dB by subtracting the lower peak-to-valley RF output, in dBm, from the upper peak-to-valley RF output, in dBm. Record the *peak-to-valley ratio* in dB. The data can also be represented in a graph of RF frequency versus SSTO voltage, calibrated in dB (see Figure 2-2).

2.19.4 Pass/Fail Criteria. The measured peak-to-valley ratio will be equal to or less than 3 dB.

2.19.5 Test Equipment Requirements. The RF signal generator output must be variable in RF amplitude in 0.1 dB increments with at least 0.5 dB accuracy, and RF frequency in 1 kHz increments with at least 100 Hz accuracy. The voltmeter used to measure the SSTO must be at least 4½ digits and have a minimum accuracy of one percent.

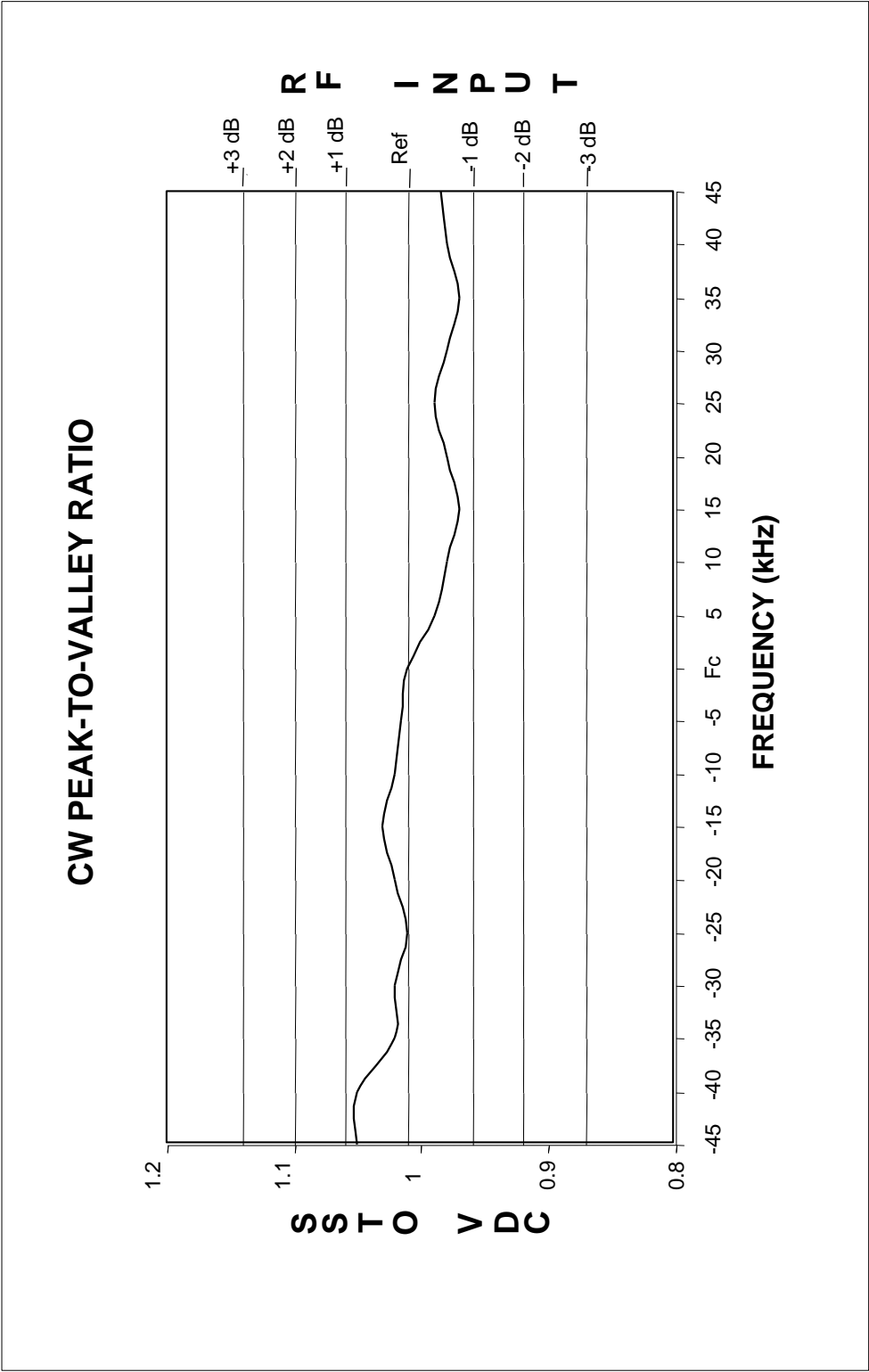

Figure 2-2. CW peak-to-valley ratio.

Test No. 20

2.20 Decoder Channel Bandwidth

2.20.1 Standard Decoder Channel Bandwidth

2.20.1.1 Purpose. This test verifies that the bandwidth of the tone decoder filter assemblies is sufficient to pass the tone sequences, reject out-of-band frequencies, and meet the design specifications.

2.20.1.2 Requirement. The FTR decoder channel bandwidth is required to generate a tone that is within the limits that are specified in the applicable component specification (RCC Document 319-99, Chapter 8, subparagraph 8.12.16).

2.20.1.3 Test.

2.20.1.3.1 Setup: Connect the unit to the test equipment as shown in Figure 1-2 and Table 2-20A.

TABLE 2-20A. TEST SETUP FOR STANDARD DECODER CHANNEL BANDWIDTH	
<u>Device</u>	<u>Settings</u>
RF Generator	
Power Output	-47 dBm
Frequency	F _o
Deviation	Varied (deviation will be set to 2 dB and 14 dB above measured threshold)
Tone Generator	
Tone A	Off
Tone B	Off
Tone C	Off
Tone D	Off
Power Supply	
Voltage	Nominal specified voltage

2.20.1.3.2 Set the RF signal generator amplitude to -47 dBm (1000 microvolts).

2.20.1.3.3 With the deviation of tone C set for 30 kHz and tone A for the measured deviation threshold for tone A plus an additional 2 dB, turn ON the ARM Command.

2.20.1.3.4 Increase tone A frequency until ARM drops out. Slowly decrease the tone A frequency until ARM comes back in and is solid. Record the frequency as the *tone A: 2 dB high frequency*. Return tone A frequency to center.

2.20.1.3.5 Increase tone A amplitude to 14 dB above the measured deviation threshold for tone A and increase tone A frequency until ARM drops out. Slowly decrease the tone A frequency until ARM comes back in and is solid. Record the frequency as the *tone A: 14 dB high frequency*. Return tone A frequency to center.

2.20.1.3.6 Decrease tone A frequency until ARM drops out. Slowly increase the tone A frequency until ARM comes back in and is solid. Record the frequency as the *tone A: 14 dB low frequency*. Return the tone A frequency to center.

2.20.1.3.7 Decrease tone A amplitude to 2 dB above the measured deviation threshold for tone A. Decrease tone A frequency until ARM drops out. Slowly increase the tone A frequency until ARM comes back in and is solid. Measure and record the frequency as the *tone A: 2 dB low frequency*. Return tone A frequency to center.

2.20.1.3.8 Return tone A amplitude to normal (± 30 kHz deviation).

2.20.1.3.9 Using the ARM command, repeat paragraphs 2.20.1.3.1 through 2.20.1.3.8 for tone C using the measured deviation threshold for tone C and adjusting the tone C frequency. Each time the frequency is increased or decreased, tone A will have to be turned OFF and then back ON prior to checking to see if the ARM command is present.

2.20.1.3.10 With tones A and C set to normal deviations (± 30 kHz), apply an ARM command. Remove tone C and verify that the ARM output is still present.

2.20.1.3.11 Repeat paragraphs 2.20.1.3.1 through 2.20.1.3.8 with tone B using the TERMINATE command and tone B measured deviation threshold and frequency. If the ARM output is lost, the ARM command will have to be resent prior to continuing.

2.20.1.3.12 Repeat paragraphs 2.20.1.3.1 through 2.20.1.3.8 using only tone D and the CHECK CHANNEL output.

2.20.1.3.13 Decoder board level acceptance test: At the decoder board level (open FTR box) where there is access to each filter assembly, a 20 dB tone filter bandwidth test will be conducted on each filter assembly instead of the 14 dB tone test. This test will be conducted only in the FTR fabrication and assembly process and not after closing the box.

2.20.1.4 Pass/Fail Criteria. The decoder channel bandwidth for each tone will meet the following requirements:

2.20.1.4.1 It will be greater than or equal to ± 1 percent of the assigned tone frequency at 2 dB.

2.20.1.4.2 It will be less than or equal to ± 4 percent of the assigned tone frequency at 14 dB when measured at the box level.

2.20.1.4.3 It will be less than or equal to ± 4 percent of the assigned tone frequency at 20 dB when measured at the decoder board level.

2.20.1.5 Test Equipment Requirements. The RF generator modulation must be variable to a resolution of at least 1 dB or greater and have a minimum accuracy of 0.5 dB. The tone frequency minimum accuracy and maximum resolution is 1 Hz.

2.20.2 Secure FTR Pilot Tone Bandwidth

2.20.2.1 Purpose. This test verifies that the bandwidth of the PILOT tone decoder is sufficient to pass the tone, reject out-of-band frequencies, and meet the design specifications.

	<p>The secure FTR decoder is a fast Fourier transform (FFT) microprocessor decoder. This test assumes that if the decoder bandwidth is correct for the PILOT tone, it is also correct for the rest of the specified commands because it uses the same FFT process.</p>
---	---

2.20.2.2 Requirement. The FTR channel bandwidth that is required to generate a tone is within the limits that are specified in the applicable component specification (RCC Document 319-99, Chapter 8, subparagraph 8.12.16).

2.20.2.3 Test.

2.20.2.3.1 Setup: Connect unit to the test equipment as shown in Figure 1-2 and Table 2-20B.

TABLE 2-20B. TEST SETUP FOR SECURE FTR PILOT TONE BANDWIDTH	
<u>Device</u>	<u>Settings</u>
RF Generator	
Power Output	-47 dBm
Frequency	F _o
Deviation	Varied (deviation will be set to 2 dB and 14 dB above measured threshold)
Tone Generator	
Pilot Tone	Off
Power Supply	
Voltage	Nominal specified voltage

2.20.2.3.2 The PILOT tone bandwidth testing will be accomplished using the same methodology as in paragraphs 2.20.1.3.1 through 2.20.1.3.8 using the PILOT tone output and adjusting the PILOT tone deviation and frequency.

2.20.2.3.3 If the secure FTR does not use the FFT microprocessor decoding scenario described in subparagraph 2.20.2.1, then the testing methodology described in this test must be readdressed.

2.20.2.4 Pass/Fail Criteria. The decoder channel bandwidth for the PILOT tone will meet the following requirements:

2.20.2.4.1 It will be greater than or equal to ± 1 percent of the assigned tone frequency at 2 dB.

2.20.2.4.2 It will be less than or equal to ± 4 percent of the assigned tone frequency at 14 dB when measured at the box level.

2.20.2.4.3 It will be less than or equal to ± 4 percent of the assigned tone frequency at 20 dB when measured at the decoder board level.

2.20.2.5 Test Equipment Requirements. The RF generator modulation must be variable to a resolution of at least 1 dB or greater with a minimum accuracy of 0.5 dB. The tone frequency minimum accuracy and maximum resolution is 1 Hz.

2.20.3 Decoder Channel Center Frequency

2.20.3.1 Purpose. This procedure analytically finds the actual tuned tone decoder center frequency using the data taken during the Decoder Channel Bandwidth test. The analysis will verify that it is within ± 0.5 percent.

2.20.3.2 Requirement. The channel filters will be centered about the RCC tone center frequency within ± 0.5 percent (RCC Document 319-99, Chapter 3, subparagraph 3.5.9.2.2.2.7).

2.20.3.3 Test.

2.20.3.3.1 Setup: None.

2.20.3.3.2 Using the data taken in paragraph 2.20.1 or 2.20.2, calculate the decoder channel center frequency for tone A. Subtract the channel low frequency from the channel high frequency, divide the difference by two, then add the quotient to the channel low frequency. Record as the *channel center frequency*.

2.20.3.3.3 Take the calculated center frequency, subtract the assigned center frequency for the tone, then divide the difference by the assigned center frequency and multiply by 100 to get the percent. Record the *percent*.

2.20.3.3.4 Perform paragraphs 2.20.3.3.2 and 2.20.3.3.3 for each tone the receiver is capable of decoding.

2.20.3.4 Pass/Fail Criteria. The decoder channel center frequency for each tone will be within ± 0.5 percent.

2.20.3.5 Test Equipment Requirements. None.

Test No. 21

2.21 Decoder Channel Deviation

2.21.1 Purpose. This test verifies that the FTR will respond properly when the input RF carrier is deviated over the range of plus and minus 27 kHz to plus and minus 33 kHz per tone. The deviation threshold for each decoder channel is between 9 and 18 kHz and the decoder channel does not respond to deviations of less than ± 9 kHz. Refer to Figure 2-3 for a pictorial of this specification.

2.21.1.2 Requirement. The FTR decoder channel deviation will meet the following requirements:

2.21.1.2.1 The FTR decoder will operate normally with a deviation of ± 27 to ± 33 kHz per tone and a two tone deviation of ± 54 to ± 66 kHz (RCC Document 319-99, Chapter 8, subparagraph 8.12.17.1).

2.21.1.2.2 The FTR decoder will not produce a decoder output at deviation levels of ± 9 kHz or less (RCC Document 319-99, Chapter 8, subparagraph 8.12.17.2).

2.21.1.2.3 The threshold deviation level at which the FTR responds to commands will be between ± 9 kHz and ± 18 kHz (RCC Document 319-99, Chapter 8, subparagraph 8.12.17.3).

2.21.1.3 Test.

2.21.1.3.1 Setup: Connect the unit to the test equipment as shown in Figure 1-2 and Table 2-21.

TABLE 2-21. TEST SETUP FOR DECODER CHANNEL DEVIATION	
<u>Device</u>	<u>Settings</u>
RF Generator	
Power Output	-47 dBm
Frequency	F _o
Deviation	Varied (deviation will be varied from ±9 kHz to ±33 kHz)
Tone Generator	
Tone A	Off
Tone B	Off
Tone C	Off
Tone D	Off
Power Supply	
Voltage	Nominal specified voltage

2.21.1.3.2 Set the RF signal generator amplitude to -47 dBm (1000 microvolts).

2.21.1.3.3 Set the deviation of tone C at ± 30 kHz and tone A at 0 kHz. Turn ON tones A and C and slowly increase the deviation of tone A until the ARM output is ON and solid. Record the *deviation threshold of tone A*.

2.21.1.3.4 Turn OFF tones A and C and set the deviation of tone A to ± 8 kHz. Turn ON tones A and C and verify that the ARM output does not come on. Record that tone A does not respond at deviations less than ± 9kHz.

2.21.1.3.5 Set the deviation of tone C at ± 30 kHz and tone A at ±27 kHz. Turn ON tones A and C and verify that the ARM output is ON and solid. Slowly increase the deviation of tone A until the tone A deviation is equal to ± 33 and verify that the ARM output is present without any dropouts. Record that tone A meets the requirement from ± 27 kHz to ± 33 kHz.

2.21.1.3.6 Repeat paragraphs 2.21.1.3.2 through 2.21.1.3.5 with tone A at ± 30 kHz and varying tone C while monitoring the ARM output. When varying the deviation of tone C from ±27 kHz to ± 33 kHz, tone A will have to be turned OFF when changing the tone C deviation to remove the ARM output since tone A latches in the ARM output.

2.21.1.3.7 Repeat paragraphs 2.21.1.3.2 through 2.21.1.3.6 with tones A and C at ± 30 kHz and varying tone B while monitoring the TERMINATE output. Before varying tone B, an ARM command has to be sent and tone C removed. If the ARM output goes OFF during the testing, resend an ARM command.

2.21.1.3.8 Repeat paragraphs 2.21.1.3.2 through 2.21.1.3.6 with tones A, C and B OFF and varying tone D while monitoring the CHECK CHANNEL output.

2.21.1.4 Pass/Fail Criteria. The decoder channel for each tone will meet the following requirements:

2.21.1.4.1 It will not respond to deviations of ± 9 kHz or less.

2.21.1.4.2 It will have a threshold deviation between ± 9 kHz and ± 18 kHz.

2.21.1.4.3 It will operate without dropouts at deviations of ± 27 kHz to ± 33 kHz.

2.21.1.4.4 Test Equipment Requirements. The RF signal generator must have the ability to vary the FM deviation from 0 to at least plus and minus 33 kHz per tone with an accuracy of at least ± 0.5 kHz.

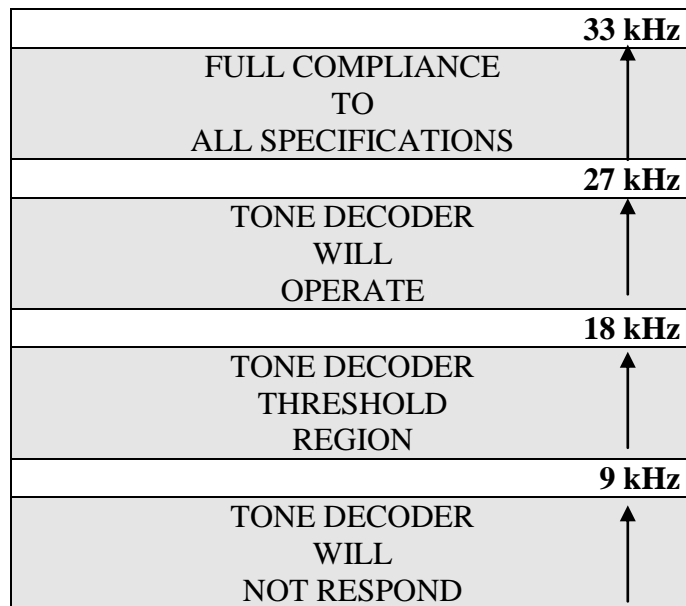

Figure 2-3. Decoder deviation.

Test No. 22

2.22 Adjacent Channel Rejection

2.22.1 Purpose. This test verifies that the FTR decoder filters and power output circuits have sufficient isolation to restrict adjacent channel interference. This test is not applicable to secure FTRs.

2.22.2 Requirement. The tone decoder channels will not respond to adjacent FM modulated tone channels when they are FM modulated with plus and minus 50 kHz per tone (RCC Document 319-99, Chapter 8, subparagraph 8.12.19).

2.22.3 Test.

2.22.3.1 Setup: Connect the unit to the test equipment as shown in Figure 1-2 and Table 2-22.

TABLE 2-22. TEST SETUP FOR ADJACENT CHANNEL REJECTION	
<u>Device</u>	<u>Settings</u>
RF Generator	
Power Output	-95 dBm
Frequency	F_o
Deviation	± 30 kHz/tone (some tones will be set for ± 50 kHz)
Tone Generator	
Tone A	Off
Tone B	Off
Tone C	Off
Tone D	Off
Power Supply	
Voltage	Nominal specified voltage

2.22.3.2 Set tone A and tone C for ± 30 kHz FM deviation/tone and send an ARM command. Verify the ARM output is ON.

2.22.3.3 Apply tone A plus 1 set to ± 50 kHz FM deviation. Verify the ARM output remains ON and only valid outputs are ON.

2.22.3.4 Remove tone A plus 1 and apply tone C minus 1 set to ± 50 kHz FM deviation. Verify that the ARM output remains ON and only valid outputs are ON.

2.22.3.5 Remove tone C minus 1 and apply tone C plus 1 set to ± 50 kHz FM deviation. Verify that the ARM output remains ON and only valid outputs are ON.

2.22.3.6 Remove tone C plus 1 and C and apply tone B set to ± 30 kHz FM deviation and verify that the TERMINATE output turns ON.

2.22.3.7 Apply tone B plus 1 set to ± 50 kHz FM deviation. Verify that the TERMINATE output remains ON and only valid outputs are ON.

2.22.3.8 Remove tones A, B and B plus 1.

2.22.3.9 If the FTR is capable of decoding a CHECK CHANNEL command, then apply tone D. Verify the CHECK CHANNEL output is ON.

2.22.3.10 Apply tone D plus 1 set to ± 50 kHz FM deviation. Verify that the CHECK CHANNEL output remains ON and only valid outputs are ON.

2.22.3.11 Remove tone D plus 1 and apply tone D minus 1 set to ± 50 kHz FM deviation. Verify that the CHECK CHANNEL output remains ON and only valid outputs are ON.

2.22.3.12 Turn OFF tones D minus 1 and D.

2.22.4 Pass/Fail Criteria. When the adjacent tones are applied at FM deviations levels of ± 50 kHz, they will not interfere with the valid commands.

2.22.5 Test Equipment Requirements. The tone encoder and RF signal generator must be capable of producing ± 50 kHz per tone FM deviation.

Test No. 23

2.23 Image and Spurious Response Rejection

2.23.1 Purpose. This test verifies that the FTR RF section can reject the image frequency and other signals outside the FTR's specified 60 dB bandwidth.

2.23.2 Requirement. The FTR RF selectivity will reject frequencies within the frequency spectrum from 10 MHz to 1000 MHz (omitting the frequency band within the 60-dB bandwidth) so they are at least 60 dB, minimum, below the measured threshold sensitivity (RCC Document 319-99, Chapter 8, subparagraphs 8.12.20 [spurious] and 8.12.26 [image]).

2.23.3 Test.

2.23.3.1 Setup: Connect the unit to the test equipment as shown in Figure 1-2 and Table 2-23.

TABLE 2-23. TEST SETUP FOR IMAGE AND SPURIOUS RESPONSE REJECTION	
<u>Device</u>	<u>Settings</u>
RF Generator	
Power Output	Measured TERMINATE command sensitivity threshold (measured in subparagraph 2.13.3.4)
Frequency	F _o (will be varied from 10 MHz to 1000 MHz)
Deviation	±30 kHz/tone
Tone Generator	
Tone A	Off
Tone B	Off
Tone C	Off
Tone D	Off
Power Supply	
Voltage	Nominal specified voltage

There are three test methods. The choice of method one or two depends upon the compliance of SSTO output. Method three is to be used in conjunction with either method one or two.

2.23.3.2 Method One. Test method one will be used for spurious responses and image frequency testing when the FTR has an SSTO output that fully complies with RCC Document 319-99. The SSTO voltage increases above the quiescent voltage level at measured threshold sensitivity by at least 0.1 Vdc.

2.23.3.2.1 Set the RF signal generator to the FTR center frequency and the RF output level to the measured TERMINATE command threshold sensitivity. Record the SSTO voltage and the RF level as the *reference levels*.

2.23.3.2.2 Calculate the *image frequency* by either adding or subtracting (depending on whether high side or low side injection is used) the intermediate frequency from the center frequency of the FTR.

2.23.3.2.3 Set the RF signal generator to the calculated image frequency.

2.23.3.2.4 Increase the RF signal generator's output level until the SSTO reference voltage recorded in subparagraph 2.23.3.2.1 is obtained. Record the *RF level*.

2.23.3.2.5 Subtract the RF level of subparagraph 2.23.3.2.4 from the reference RF level. Record the difference as the *image frequency rejection*.

2.23.3.2.6 Set the RF signal generator to 10 MHz and the RF level to the level recorded in subparagraph 2.23.3.2.1 plus an additional 60 dB.

2.23.3.2.7 Slowly increase the RF signal generator RF frequency in 1 kHz increments (nominal) to 1000 MHz, omitting the frequency band within the 60-dB bandwidth, while viewing the SSTO level for increases. Record any frequencies outside the bandwidth of the receiver that cause the SSTO voltage to increase above the reference level by a significant amount (>200 millivolts).



The harmonics of the assigned center frequency can be disregarded if it can be shown that the responses are caused by RF signal generator harmonics.

2.23.3.2.8 With the signal generator tuned to the frequencies noted in subparagraph 2.23.3.2.7, decrease the signal generator output until the FTR SSTO returns to the reference level. Record the difference between the reference RF level and the RF level necessary to return the SSTO to the reference level.

2.23.3.3 Method Two. Test method two will be used for spurious responses and image frequency testing when the FTR has an SSTO output that does not fully comply with RCC Document 319-99. The SSTO voltage level at quiescent and measured threshold are the same.

2.23.3.3.1 Set the RF signal generator set to the FTR center frequency and the RF output level to the measured TERMINATE command threshold sensitivity.

2.23.3.3.2 Transmit an ARM command and verify that the ARM output is ON. Record the RF level as the *reference levels*.

2.23.3.3.3 Calculate the *image frequency* by either adding or subtracting (depending on whether high side or low side injection is used) the intermediate frequency from the center frequency of the FTR.

2.23.3.3.4 Set the RF signal generator to the calculated image frequency and transmit an ARM command.

2.23.3.3.5 Increase the RF signal generator's output level until the ARM command output is present or 0 dBm is reached. Record the *RF level*.

2.23.3.3.6 Subtract the RF level of subparagraph 2.23.3.3.5 from the reference RF level. Record the difference as the *image frequency rejection*.

2.23.3.3.7 Set the RF signal generator to 10 MHz and the RF level to the level recorded in subparagraph 2.23.3.3.2 plus an additional 60 dB.

2.23.3.3.8 Transmit an ARM command and slowly increase the RF signal generator RF frequency in 1 kHz increments (nominal) to 1000 MHz, omitting the frequency band within the 60 dB bandwidth, while viewing the ARM output. Record any frequencies outside the receiver bandwidth that cause an ARM output.



The harmonics of the assigned center frequency can be disregarded if it can be shown that the responses are caused by RF signal generator harmonics.

2.23.3.3.9 With the signal generator tuned to the frequencies noted in subparagraph 2.23.3.3.8, decrease the signal generator output until the ARM output goes OFF. Record the difference between the reference RF level and the RF level necessary to turn off the ARM output.

2.23.3.4 Method Three. Test method three is used to determine if another transmitter operating in the 420 - 450 MHz band could cause a response from the receiver. This test is to be performed in addition to either method one or two and is used to determine if additional operational constraints may be required. If spurious command triggering occurs at +13 dBm or less, additional analyses or operational constraints may be necessary to ensure that one program operating on a vulnerable frequency identified by this test will not adversely affect the safety of another program.

2.23.3.4.1 Set the RF signal generator to 420 MHz and the RF level to +13 dBm.

2.23.3.4.2 Transmit an ARM command and slowly increase the RF signal generator RF frequency in 1 kHz increments (nominal) to 450 MHz, omitting the frequency band within the 60 dB bandwidth, while viewing the ARM output. Record any frequencies outside the receiver bandwidth that cause an ARM output.

2.23.3.4.3 With the signal generator tuned to the frequencies noted in subparagraph 2.23.3.4.2, decrease the signal generator output until the ARM output goes OFF. Record the *difference* between the reference RF level and the RF level necessary to turn off the ARM output.

2.23.3.4.4 Repeat paragraphs 2.23.3.4.1 through 2.23.3.4.3 for each command the receiver is capable of decoding, including CHECK CHANNEL.

2.23.4 Pass/Fail Criteria. The image rejection and the rejection of all other frequencies outside the 60 dB bandwidth of the FTR will be at least 60 dB. If during method three, spurious command triggering occurs at +13 dBm or less, additional analyses or operational constraints

may be necessary to ensure that one program operating on a vulnerable frequency identified by this test will not adversely affect the safety of another program.

2.23.5 Test Equipment Requirements. The RF signal generator must have a frequency resolution and accuracy of at least 1 kHz and an amplitude resolution of 1 dB with a minimum accuracy of 0.5 dB.

Test No. 24

2.24 Capture Ratio

2.24.1 Purpose. This test determines the FTR's ability to reject undesired or interference signals while accepting desired signals. In addition, it verifies that the FTR also does not produce false outputs in the presence of the undesired signals.

2.24.2 Requirement. The FTR will not be captured and/or interfered with when it is subjected to an unmodulated RF signal level up to 80 percent (-2 dB) of the desired modulated RF carrier signal at the same frequency (RCC Document 319-99, Chapter 8, subparagraph 8.12.21).

2.24.3 Test.

2.24.3.1 Setup: Connect the unit to the test equipment as shown in Figure 1-2 and Table 2-24.

TABLE 2-24. TEST SETUP FOR CAPTURE RATIO	
<u>Device</u>	<u>Settings</u>
RF Generator #1	
Power Output	-67 dBm (will be varied)
Frequency	F_o
Deviation	± 30 kHz/tone
Tone Generator	
Tone A	Off
Tone B	Off
Tone C	Off
Tone D	Off
Power Supply	
Voltage	Nominal specified voltage
RF Generator #2	
Power Output	-67 dBm (will be varied)
Frequency	F_o
Deviation	Off



RF generator #1 will be used to send commands in a normal manner (representing the valid signal) and RF generator #2 will be used to generate a CW signal (representing the invalid signal).

2.24.3.2 Configure both RF generator RF outputs through a combiner (inverse power divider) to the FTR RF input. Set both RF generators to the assigned center frequency.

2.24.3.3 Turn RF generator #1's RF OFF. Turn RF generator #2's RF ON. Set RF generator #2 RF output for -67 dBm (100 μ volts) and read the SSTO voltage. Record as the *SSTO reference level*. Turn RF generator #2's RF OFF or set for RF minimum.

2.24.3.4 Turn RF generator #1's RF ON and adjust the RF amplitude until the SSTO reads the same as the SSTO reference level.

2.24.3.5 Modulate RF generator #1 one with an ARM command and verify the FTR's ARM output is ON and stable.

2.24.3.6 Set RF generator #2 for -85 dBm and turn ON RF generator #2's unmodulated RF output. Slowly increase the RF amplitude until the FTR decoder ARM output turns OFF or becomes intermittent.

2.24.3.7 Record RF generator #2's *RF output amplitude* in microvolts.

2.24.3.8 Calculate the *capture ratio* by dividing the "microvolts of the interfering signal" (see subparagraph 2.24.3.6) by the "microvolts for the 100 microvolt reference." The quotient is the ratio (minimum of 0.8). The ratio can be expressed in a percentage by multiplying the quotient by 100 (minimum of 80 percent/-2 dB). Refer to Figure 2-4.

$$\text{Ratio} = \frac{\text{Measured (} \mu\text{volts)}}{\text{Reference Level (100 } \mu\text{volts)}}$$

2.24.4 Pass/Fail Criteria. The capture ratio will be a minimum of 80% (-2 dB).

2.24.5 Test Equipment Requirements. Both RF generators must have variable RF outputs that can be set in microvolts.

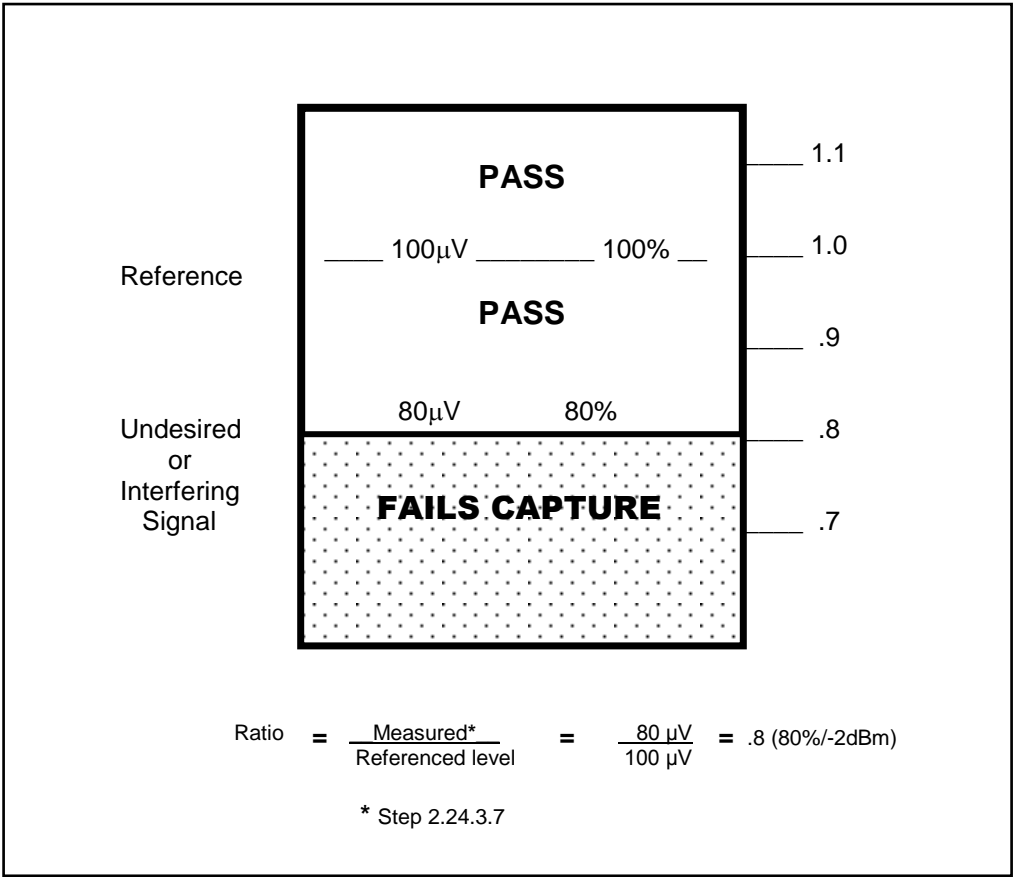

Figure 2-4. Capture ratio.

Test No. 25

2.25 Amplitude Modulation (AM) Rejection 50% and 100%

2.25.1 Purpose. This test verifies that the FTR discriminator limiters are functioning properly.

2.25.2 Requirement. The FTR will reject an AM modulated signal and will not produce an output from any decoder channel under the following conditions (RCC Document 319-99, Chapter 8, subparagraphs 8.12.22, 8.12.22.1, 8.12.22.2 and 8.12.22.3):

2.25.2.1 An RF input signal at the assigned center frequency of -90.1 dBm (7 μ V) with 50-percent AM modulation by the assigned RCC tone frequencies.

2.25.2.2 An RF input signal at the assigned center frequency of -85.4 dBm (12 μ V) with 50-percent AM modulation at any modulation frequency.

2.25.2.3 An RF input signal at the assigned center frequency of -67 dBm (100 μ V) with 100-percent peak AM modulation at low pass filter (LPF) 3 dB frequencies of 3.5 kHz or 7.0 kHz.

2.25.3 Test.

2.25.3.1 Setup: Connect the unit to the test equipment as shown in Figure 1-2 and Table 2-25.

TABLE 2-25. TEST SETUP FOR AM REJECTION 50% and 100%	
<u>Device</u>	<u>Settings</u>
RF Generator	
Power Output	-90.1, -85.4, and -67 dBm (7, 12, and 100 microvolts)
Frequency	F_o
Deviation	No FM (will be set to AM)
Tone Generator	
Tone A	Off
Tone B	Off
Tone C	Off
Tone D	Off
Power Supply	
Voltage	Nominal specified voltage

2.25.3.2. 50 Percent AM.

2.25.3.2.1 Set the RF signal generator RF level to -90.1 dBm (7 microvolts) and the modulation input to amplitude modulation (AM).

2.25.3.2.2 Apply RCC tones A and C and adjust the RF signal generator amplitude modulation to 50 percent. Verify and record any FTR decoder outputs. If an ARM decoder output is present, remove tone C and apply tone B. Verify and record any FTR decoder outputs.

2.25.3.2.3 If the FTR is capable of decoding an OPTIONAL command, apply RCC tones B and C. Verify and record any FTR decoder outputs.

2.25.3.2.4 If the FTR is capable of decoding a CHECK CHANNEL, apply RCC tone D. Verify and record any FTR decoder outputs.

2.25.3.2.5 Repeat for any additional tone combinations that the FTR is specified to be capable of decoding. Record any FTR decoder outputs.

2.25.3.2.6 Set the RF signal generator RF level to -85.4 dBm (12 microvolts).

2.25.3.2.7 Modulate the RF signal generator with a noise generator with a minimum bandpass of 1 Hz to 600 kHz and adjust the RF signal generator amplitude modulation to 50 percent.

2.25.3.2.8 Monitor the FTR decoder outputs for a minimum of one minute and record any outputs.

2.25.3.3 100 Percent AM.

2.25.3.3.1 Set the RF signal generator RF level to -67 dBm (100 microvolts).

2.25.3.3.2 Modulate the RF signal generator with a noise generator that has a low pass filter with an upper 3-dB cutoff of 3.5 or 7.0 kHz and adjust the RF signal generator amplitude modulation to 100 percent.

2.25.3.3.3 Monitor the FTR decoder outputs for a minimum of one minute and record any outputs.

2.25.4 Pass/Fail Criteria. No decoder channel outputs will be produced when the FTR input RF is AM modulated at 50 percent or 100 percent.

2.25.5 Test Equipment Requirements. The RF signal generator must have the capability of being amplitude modulated with the RCC tones and noise from 0 to 100 percent with a desired resolution of 1 percent (nominal). The noise generator must have a minimum bandwidth of 1 Hz to 600 kHz and the low pass filter must have an upper cutoff frequency of 3.5 kHz or 7.0 kHz.

Test No. 26

2.26 Response Time (Standard FTR)

2.26.1 Purpose. This test measures and verifies the inherent delay of an RF command to process through the combined receiver/decoder.

2.26.2 Requirement. The minimum /maximum activation time will be specified in the applicable specification but will not be less than 4 milliseconds nor greater than 25 milliseconds when tested at the specified threshold sensitivity (RCC Document 319-99, Chapter 8, subparagraph 8.12.23).

2.26.3 Test.

2.26.3.1 Setup: Connect the unit to the test equipment as shown in Figure 1-2 and Table 2.26A.

TABLE 2-26A. TEST SETUP FOR RESPONSE TIME (Standard FTR)	
<u>Device</u>	<u>Settings</u>
RF Generator	
Power Output	-67 dBm
Frequency	F _o
Deviation	±30 kHz/tone)
Tone Generator	
Tone A	Off
Tone B	Off
Tone C	Off
Tone D	Off
Power Supply	
Voltage	Nominal specified voltage

 **NOTE** The response time is the time required for the FTR to activate a channel output after a command signal is applied to the RF input.

2.26.3.2 Connect the time interval counter so that it starts concurrently with the application of the start-time tone to the FTR receiver and stops concurrently with the command-under-test output. Test each tone according to the configuration in Table 2-26B.

TABLE 2-26B. COMMAND FUNCTIONS			
<u>Command Under Test</u>	<u>Tones</u>	<u>Start Time</u>	<u>Stop Time</u>
ARM	A and C <u>ON</u>	Tone C <u>ON</u>	ARM output
TERMINATE	A & C <u>ON</u> C <u>OFF</u> A & B <u>ON</u>	Tone B <u>ON</u>	TERMINATE output
OPTIONAL*	B & C <u>ON</u>	Tone C <u>ON</u>	OPTIONAL output
CHECK CHANNEL*	D <u>ON</u>	Tone D <u>ON</u>	CHECK CHANNEL output
* if applicable			

2.26.3.3 Perform the measurement ten times for each command.

2.26.3.4 Record for each command the *minimum response time* measured, the *maximum response time* measured, and the *average of the response times* for the ten measurements.

2.26.4 Pass/Fail Criteria. The average response time for each command will be greater than or equal to 4 milliseconds but less than or equal to 25 milliseconds.

2.26.5 Test Equipment Requirements. The time interval measurement instrument must be capable of a measurement display resolution of at least 0.5 milliseconds and a minimum accuracy of 0.05 milliseconds.

Test No. 27

2.27 Output Load Characteristics

2.27.1 Purpose. This test verifies that the FTR is capable of providing the specified power output into the specified load impedance characteristics.

2.27.2 Requirement. The FTR will be capable of outputting the specified power to the specified load on each output at any FTR input power supply voltage level between the minimum and

maximum specified voltage per the procurement specifications (RCC Document 319-99, Chapter 8, subparagraph 8.12.25).

2.27.3 Test.

2.27.3.1 Setup: Connect the unit to the test equipment as shown in Figure 1-2 and Table 2-27.

TABLE 2-27. TEST SETUP FOR OUTPUT LOAD CHARACTERISTICS	
<u>Device</u>	<u>Settings</u>
RF Generator	
Power Output	-47 dBm
Frequency	F _o
Deviation	±30 kHz/tone
Tone Generator	
Tone A	Off
Tone B	Off
Tone C	Off
Tone D	Off
Power Supply	
Voltage	Minimum, maximum and nominal specified voltage
Output loads	Per the procurement specifications

2.27.3.2 Adjust the dc power to the FTR to nominal and apply power.

2.27.3.3 Connect the appropriate load to the command output. Initiate the appropriate command. Verify that the FTR can sustain the output voltage level and current requirements for the specified time. Record the *current and output voltage*.



If the FTR contains relays on the command output channels, the output loads should not be applied until after the RF command output has been initiated and should be removed prior to removing the command to prevent arcing of the relay contacts.

It is essential that the exact specified load and the exact time limits for application of loads to the FTR output be adhered to (per specifications).

2.27.3.4 Repeat paragraph 2.27.3.3 for each command output.

2.27.3.5 Connect the appropriate load to the telemetry monitor output and with the FTR ON and the telemetry monitor output OFF, record the *monitor output voltage*.

2.27.3.6 Turn ON the telemetry monitor output and record the *output voltage*.

2.27.3.7 Repeat paragraphs 2.27.3.5 and 2.27.3.6 for each telemetry monitor output except the signal strength telemetry output (SSTO).

2.27.3.8 Adjust the dc power to the FTR to the minimum specified voltage and repeat paragraphs 2.27.3.3 through 2.27.3.7.

2.27.3.9 Adjust the dc power to the FTR to the maximum specified voltage and repeat paragraphs 2.27.3.3 through 2.27.3.7.

2.27.4 Pass/Fail Criteria. The FTR monitor and command outputs will meet the output power requirements of the procurement specification when operating into the specified load.

2.27.5 Test Equipment Requirements. The loads placed on the FTR outputs must be as specified in the procurement specification. The dc power source must be capable of providing the direct current necessary to sustain the FTR power requirements.

Test No. 28

2.28 Dynamic Stability

2.28.1 Purpose. This test verifies that there are no abnormal, undesirable, or false decoder outputs during an open, shorted, or terminated RF input to the FTR.

2.28.2 Requirement. The FTR will not produce any false commands or spurious outputs when subjected to a change in the input VSWR and/or open and short circuit conditions of the RF input source (RCC Document 319-99, Chapter 8, subparagraph 8.12.28).

2.28.3 Test.

2.28.3.1 Setup: Connect the unit to the test equipment as shown in Figure 1-2 and Table 2-28.

TABLE 2-28. TEST SETUP FOR DYNAMIC STABILITY	
<u>Device</u>	<u>Settings</u>
RF Generator	
Power Output	Disconnect
Frequency	F_o
Deviation	Off
Tone Generator	
Tone A	Off
Tone B	Off
Tone C	Off
Tone D	Off
Power Supply	
Voltage	Nominal specified voltage

2.28.3.2 Provide dc power to the FTR. Monitor all decoder and tone outputs. Connect a 50 ohm termination to the FTR RF input. Observe the decoder outputs for one minute. Verify that there are no false output.

2.28.3.3 Disconnect the 50-ohm termination and connect a coaxial open to the RF input. (The RF input connector may be left unconnected for this test in lieu of a coaxial open). Observe the decoder outputs for one minute. Verify that there are no false outputs.

2.28.3.4 Connect a coaxial short to the RF input. Observe the decoder outputs for one minute.

2.28.4 Pass/Fail Criteria. No decoder or tone outputs will be generated under the different VSWR conditions.

2.28.5 Test Equipment Requirements. The RF coaxial terminating devices (short, open, and 50-ohm load) will be required with the necessary mating connectors.

Test No. 29

2.29 Quieting Sensitivity

2.29.1 Purpose. This test measures the amount of RF required to quiet the FTR when it contains automatic gain control (AGC) circuitry.

2.29.2 Requirement. The AGC circuitry will provide a minimum of 10 dB of receiver quieting at an RF input level that is not greater than 3 dB above the measured receiver threshold sensitivity (RCC Document 319-99, Chapter 3, subparagraph 3.5.9.2.2.1.12).

2.29.3 Test.

2.29.3.1 Setup: Connect the unit to the test equipment as shown in Figure 1-2 and Table 2-29.

TABLE 2-29. TEST SETUP FOR QUIETING SENSITIVITY	
<u>Device</u>	<u>Settings</u>
RF Generator	
Power Output	Off
Frequency	F _o
Deviation	Off
Tone Generator	
Tone A	Off
Tone B	Off
Tone C	Off
Tone D	Off
Power Supply	
Voltage	Nominal specified voltage



This test is only applicable to FTRs containing AGC circuitry and will be accomplished at the printed-circuit board level if the FTR does not have an audio output.

2.29.3.2 Connect an rms voltmeter to the audio output and apply dc source power to the FTR. With FTR RF input unconnected and unterminated, measure the audio output level on the rms voltmeter. This measurement will be the *reference level*.

2.29.3.3 Set the RF signal generator output to minimum and connect it to the FTR RF input. Slowly increase the RF output until the audio output decreases 10 dB below the reference level taken in subparagraph 2.29.3.2. Note the *RF level*.

2.29.3.4 Compare the RF level taken in subparagraph 2.29.3.3 to the TERMINATE command threshold sensitivity recorded in subparagraph 2.13.3.4. The RF level that is required to produce 10 dB of receiver quieting will be less than 3 dB above the measured sensitivity.

2.29.4 Pass/Fail Criteria. The measured RF level required to produce 10 dB of receiver quieting will be less than 3 dB above the measured FTR sensitivity.

2.29.5 Test Equipment Requirements. The rms voltmeter must have a readout resolution of 1 dB and have a minimum accuracy of one percent.

Test No. 30

2.30 Out-of-Band Rejection

2.30.1 Purpose. This test verifies that the FTR is immune to out-of-band signals. As a minimum, those high-level RF signals originating from or expected to be present on the missile must be tested. If MIL-STD-461, test CS104, is tailored to include these limits, this test is not applicable.

2.30.2 Requirement. The FTR will not respond to RF signals that are out-of-band as stated in the applicable component specification (RCC Document 319-99, Chapter 8, subparagraph 8.12.29).

2.30.3 Test.

2.30.3.1 Setup: Connect the unit to the test equipment as shown in Figure 1-2 and Table 2-30.

TABLE 2-30. TEST SETUP FOR OUT-OF-BAND REJECTION	
<u>Device</u>	<u>Settings</u>
RF Generator	
Power Output	Measured TERMINATE command sensitivity threshold (measured in subparagraph 2.13.3.4)
Frequency	F _o (will be varied from 2.2 to 2.4 and 5.4 to 5.9 GHz)
Deviation	±30 kHz/tone
Tone Generator	
Tone A	Off
Tone B	Off
Tone C	Off
Tone D	Off
Power Supply	
Voltage	Nominal specified voltage

2.30.3.2 Set the RF signal generator to the FTR center frequency and the RF output level to the measured TERMINATE command threshold sensitivity. Record the *SSTO voltage* and the *RF level* as the *reference levels*.

2.30.3.3 Connect an RF signal generator capable of emitting the necessary signals to the FTR RF input. Set the RF amplitude to 60 dB above the level referenced in subparagraph 2.30.3.2.

2.30.3.4 Slowly sweep, as a minimum, the frequency bands of 2.2 to 2.4 and 5.4 to 5.9 GHz and any other frequencies specified in the procurement specification while viewing the SSTO level for increases. Sweep increments will be 1 kHz (nominal).

2.30.3.5 Record any frequencies that cause the SSTO voltage to increase above the reference level by a significant amount (>200 millivolts).

 <p>NOTE</p>	The harmonics of the assigned center frequency can be disregarded if it can be shown that the responses are caused by the RF signal generator harmonics.
--	--

2.30.3.6 With the signal generator tuned to the frequencies noted in subparagraph 2.30.3.5 decrease the signal generator output until the FTR SSTO returns to the reference level. Record the *difference* between the reference RF level and the RF level necessary to return the SSTO to the reference level.

2.30.4 Pass/Fail Criteria. The FTR rejection of all frequencies in the applicable component specification will be at least 60 dB.

2.30.5 Test Equipment Requirements. The RF signal generator must have a frequency resolution and accuracy of at least 1 kHz and an amplitude resolution of 1 dB with a minimum accuracy of 0.5 dB.

Test No. 31

2.31 Noise Immunity

2.31.1 Purpose. This test verifies that the FTR does not produce decoder outputs when the RF input is modulated with white noise.

2.31.2 Requirement. The FTR will not produce a command output when subjected to an RF signal of -95 dBm that is FM modulated with white noise at an amplitude that is at least 12 dB higher than the measured deviation threshold of any individual tone. The white noise spectrum will be at least 0 - 600 kHz (RCC Document 319-99, Chapter 8, subparagraph 8.12.30).

2.31.3 Test.

2.31.3.1 Setup: Connect the unit to the test equipment as shown in Figure 1-2 and Table 2-31.

TABLE 2-31. TEST SETUP FOR NOISE IMMUNITY	
Device	Settings
RF Generator	
Power Output	-95 dBm
Frequency	F_o
Deviation	Highest measured deviation threshold of any individual tone (subparagraph 2.21)
Tone Generator	
Tone A	Off
Tone B	Off
Tone C	Off
Tone D	Off
Power Supply	
Voltage	Nominal specified voltage

Using one of two methods, record any outputs from the FTR:

2.31.3.2 Method One.

2.31.3.2.1 Set the RF signal generator RF level to -95 dBm and the deviation level to the highest measured deviation threshold of any individual tone (subparagraph 2.21). Record the deviation level as the *reference deviation level*.

2.31.3.2.2 Modulate the RF signal generator with a noise generator having a minimum bandpass of 0 Hz to 600 kHz, and increase the RF signal generator modulation deviation 12 dB above the reference deviation level.

2.31.3.2.3 Monitor the FTR decoder outputs for a minimum of one minute and record any outputs.

2.31.3.3 Method Two (Preferred).

2.31.3.3.1 Inject noise that is 12 dB above the highest threshold level directly into the decoder at the decoder printed-circuit (pc) board level. The minimum noise band will be from 0 to 600 kHz.

2.31.3.3.2 Observe the FTR decoder outputs for one minute and record any outputs.

2.31.4 Pass/Fail Criteria. The FTR will not produce any command or tone outputs.

2.31.5 Test Equipment Requirements. The white-noise generator will be capable of modulating the RF signal generator with sufficient audio output voltage to ensure proper modulation levels.

Test No. 32

2.32 Decoder Logic

If an FTR does not have built-in logic capabilities, the testing requirements of this paragraph do not apply.

2.32.1 Standard Logic

2.32.1.1 Purpose. This test verifies that the FTR responds to the desired RCC standard logic or logic sequences and does not respond to any other logic or logic sequences.

2.32.1.2 Requirement. The FTR will respond to specified logic and will not respond to abnormal logic (RCC Document 319-99 Table 8-10 and Chapter 8, subparagraph 8.12.46).

2.32.1.3 Test.

2.32.1.3.1 Setup: Connect the unit to the test equipment as shown in Figure 1-2 and Table 2-32A.

TABLE 2-32A. TEST SETUP FOR DECODER STANDARD LOGIC	
Device	Settings
RF Generator	
Power Output	-47 dBm
Frequency	F _o
Deviation	±30 kHz/tone
Tone Generator	
Tone A	Off
Tone B	Off
Tone C	Off
Tone D	Off
Power Supply	
Voltage	Nominal specified voltage

 **NOTE** Any deviations from the standard commands and command sequences as provided in Table 2-32C will require approval from the LRSO (RCC Document 319-99, Table 8-10).

2.32.1.3.2 Apply each logic test from Table 2-32C. Verify and record the outputs are as indicated per the table.

2.32.1.3.3 If the FTR is designed to decode CHECK CHANNEL, apply RCC tone D and repeat all the logic tests. CHECK CHANNEL must not interfere with the decoding of the other desired outputs.

2.32.1.3.4 If the FTR is designed to decode additional RCC tone combinations, additional test procedures must be designed and must be approved by the LRSO.

2.32.1.4 Pass/Fail Criteria. The FTR will process the commands properly and will not have any undesired output, whether on a monitor or command output channel.

2.32.1.5 Test Equipment Requirements. All FTR outputs for telemetry monitoring and command outputs must be continuously monitored during this test.

2.32.2 Secure Logic.

2.32.2.1 Purpose. This test verifies that the **secure** FTR responds only to the desired secure logic or secure logic sequences.

2.32.2.2 Requirement. The FTR will reject a message that has been altered by one tone number from a valid command. (RCC Document 319-99, Chapter 8, subparagraph 8.12.40).

2.32.2.3 Test.

2.32.2.3.1 Setup: Connect the unit to the test equipment as shown in Figure 1-2 and Table 2-32B.

TABLE 2-32B. TEST SETUP FOR SECURE DECODER LOGIC	
<u>Device</u>	<u>Settings</u>
RF Generator	
Power Output	-47 dBm
Frequency	F_o
Deviation	± 30 kHz/tone
Tone Generator	
	Secure tones will be used
Power Supply	
Voltage	Nominal specified voltage

2.32.2.3.2 Apply the secure tones representing the approved logic sequence in the procurement specification.

2.32.2.3.3 Apply each of the secure logic sequences described in the procurement specification.

2.32.2.4 Pass/Fail Criteria. The FTR will process the commands properly and will not have any undesired output, either on a monitor or a command output channel.

2.32.2.5 Test Equipment Requirements. All FTR outputs for telemetry monitoring and command outputs must be continuously monitored during this test.

TABLE 2-32C. STANDARD LOGIC VERIFICATION TEST (Page 1 of 2)

<u>Step</u>	<u>Switch Sequence</u>	<u>Required FTR Output</u>	<u>Tones On</u>
01	None	None	None
02	A <u>ON</u>	None	A
03	B <u>ON</u>	None	A, B
04	C <u>ON</u>	ARM	A, B, C
05	C <u>OFF</u>	ARM and TERMINATE	A, B
06	B <u>OFF</u>	ARM	A
07	C <u>ON</u>	ARM	A, C
08	B <u>ON</u>	ARM	A, B, C
09	B <u>OFF</u>	ARM	A, C
10	C <u>OFF</u>	ARM	A
11	A <u>OFF</u>	None	None
12	B <u>ON</u>	None	B
13	A <u>ON</u>	None	A, B
14	C <u>ON</u>	ARM	A, B, C
15	C <u>OFF</u>	ARM and TERMINATE	A, B
16	A <u>OFF</u>	None	B
17	C <u>OFF</u>	OPTIONAL	B, C
18	A <u>ON</u>	ARM	A, B, C
19	A <u>OFF</u>	OPTIONAL	B, C
20	C <u>OFF</u>	None	B
21	B <u>OFF</u>	None	None
22	C <u>ON</u>	None	C
23	A <u>ON</u>	ARM	A, C
24	B <u>ON</u>	ARM	A, B, C

TABLE 2-32C. STANDARD LOGIC VERIFICATION TEST (Page 2 of 2)

<u>Step</u>	<u>Switch Sequence</u>	<u>Required FTR Output</u>	<u>Tones On</u>
25	B <u>OFF</u>	ARM	A, C
26	A <u>OFF</u>	None	C
27	B <u>ON</u>	OPTIONAL	B, C
28	A <u>ON</u>	ARM	A, B, C
29	A <u>OFF</u>	OPTIONAL	B, C
30	B <u>OFF</u>	None	C
31	C <u>OFF</u>	None	None
32	A <u>ON</u>	None	A
33	C <u>ON</u>	ARM	A, C
34	B <u>ON</u>	ARM	A, B, C
35	C <u>OFF</u>	ARM and TERMINATE	A, B
36	B <u>OFF</u>	ARM	A
37	A <u>OFF</u>	None	None
38	A <u>ON</u>	None	A
39	C <u>ON</u>	ARM	A, C
40	C <u>OFF</u>	ARM	A
41	B <u>ON</u>	ARM and TERMINATE	A, B
42	All Tones <u>OFF</u>	None	None
43	D <u>ON</u>	CHECK CHANNEL	D
44	D <u>OFF</u>	None	None
45	D <u>ON</u> and repeat steps 01 through 44		

Test No. 33

2.33 Audio Output

2.33.1 Purpose. This test verifies that the audio frequency output complies with the procurement specification. This test is designed to measure the frequency and flatness response to the IF converter assembly/circuitry. This test only applies to those FTRs that have an audio output.

2.33.2 Requirement. The FTR audio output will meet the requirements of the procurement specification (RCC Document 319-99, Chapter 8, subparagraph 8.12.47).



The nominal flatness response is ± 3 dB or as specified in the procurement specification document. The frequency response is 7.5 to 32 kHz or as specified in the procurement specification document.

2.33.3 Test.

2.33.3.1 Setup: Connect the unit to the test equipment as shown in Figure 1-2 and Table 2-33.

TABLE 2-33. TEST SETUP FOR AUDIO OUTPUT	
<u>Device</u>	<u>Settings</u>
RF Generator	
Power Output	-70 dBm
Frequency	F _o
Deviation	± 30 kHz/tone
Tone Generator	
Tone A	Off
Tone B	Off
Tone C	Off
Tone D	Off
Power Supply	
Voltage	Nominal specified voltage

2.33.3.2 Configure the test setup to frequency modulate the RF signal generator at ± 30 kHz with the audio generator (AG). Connect an rms voltmeter to the FTR audio output connector with the audio output terminated into the specified load. Set the voltmeter to measure voltage.



The voltmeter is set to read voltage, because it operates at a much higher rate than when reading dB. The voltage will be converted to dB later. The rms voltmeter may be read in dB, if it has this capability.

2.33.3.3 Set the AG to 7 kHz or the minimum frequency specified in the procurement specification minus 0.5 kHz.

2.33.3.4 Increase the AG frequency in 100 Hz increments to 32.5 kHz or the maximum frequency specified in the procurement specification plus 0.5 kHz. Record the *rms voltmeter voltage* reading at each increment.

2.33.3.5 Convert the minimum and maximum dB specified values to voltages:

$$\text{dB} = 20\log_{10} (V/V_r)$$

where

$$\begin{aligned} V &= \text{Voltage} \\ V_r &= \text{Reference voltage} = 0.3535 V_{\text{rms}} \text{ (or specified nominal voltage)} \end{aligned}$$

then +3 dB:

$$\begin{aligned} +3 \text{ dB} &= 20\log_{10} (V/0.3535) \\ 3/20 &= \log_{10} (V/0.3535) \\ 10^{(0.15)} &= V/0.3535 \\ 1.4125375 &= V/0.3535 \\ V &= 0.500 \end{aligned}$$

-3 dB:

$$\begin{aligned} -3 \text{ dB} &= 20\log_{10} (V/0.3535) \\ 3/20 &= \log_{10} (V/0.3535) \\ 10^{(0.15)} &= V/0.3535 \\ 1.4125375 &= V/0.3535 \\ V &= 0.250 \end{aligned}$$

2.33.3.6 Verify that all readings recorded in subparagraph 2.34.3.4 are between 0.25 and 0.50 V_{rms} (or specified minimum and maximum) which conforms to ± 3 dB. Pay special attention to the minimum and maximum readings.

2.33.4 Pass/Fail Criteria. All readings will meet the minimum and maximum specified values from the procurement specification.

2.33.5 Test Equipment Requirements. Audio generator must sweep from 7.5 to 32 kHz. An rms voltmeter is required.

Test No. 34

2.34 Fail Safe

2.34.1 Purpose. This test verifies that the fail safe circuitry of the FTR is functional and meets the design specifications. This test only applies to those FTRs that have the fail safe capability.

2.34.2 Requirement. The fail-safe circuitry of the FTR will meet the design specification (RCC Document 319-99, Chapter 8, subparagraph 8.12.48).

2.34.3 Test.

2.34.3.1 Setup: Connect the unit to the test equipment as shown in Figure 1-2 and Table 2-34.

TABLE 2-34. TEST SETUP FOR FAIL SAFE	
<u>Device</u>	<u>Settings</u>
RF Generator	
Power Output	-95 dBm
Frequency	F _o
Deviation	±30 kHz/tone
Tone Generator	
Tone A	Off
Tone B	Off
Tone C	Off
Tone D	Off
Power Supply	
Voltage	Nominal specified voltage

2.34.3.2 Configure a second dc power supply to the FTR that will permit application of a voltage to the fail safe enable input connector pins. The fail safe circuitry connector pins will be referred to as "FAIL-SAFE ENABLE."

2.34.3.3 With the receiver powered up and the fail-safe tone ON, apply a pulse to the FAIL-SAFE ENABLE that is equal to the minimum specified voltage and pulse width.

2.34.3.4 Remove the fail-safe tone for half of the minimum specified loss of tone time and then reapply the fail-safe tone. After waiting twice the length of the maximum loss of tone fail-safe time, verify that the TERMINATE output remains OFF.

2.34.3.5 Remove the fail-safe tone and measure the time from removal of the tone to when the TERMINATE output turns ON. Record the time as the *fail-safe loss of tone time*.

2.34.3.6 Remove the FTR power. Reapply FTR power and perform paragraph 2.34.3.3.

2.34.3.7 Turn OFF the RF input and measure the time from removal of the RF to when the TERMINATE output turns ON. Record the time as the *fail-safe loss of RF time*.

2.34.3.8 Remove the FTR power. Reapply the FTR power, the RF input and the fail-safe tone.

2.34.3.9 Without applying the fail-safe enable pulse, lower the primary dc voltage to the FTR in 1 Vdc increments to 2 volts below the minimum specified fail-safe voltage. At each incremental setting, verify the FTR does not have a TERMINATE output. Reset the primary dc voltage to nominal.

2.34.3.10 Reapply the fail-safe enable pulse according to paragraph 2.34.3.3.

2.34.3.11 Lower the primary dc voltage to the FTR in 0.5 Vdc increments until the FTR has a TERMINATE output or until 2 volts below the minimum specified fail-safe voltage is reached. Record the input voltage when the TERMINATE output occurs as the *fail-safe low voltage*.

2.34.3.12 Remove the FTR input voltage. Reapply the FTR power, the RF input and the fail-safe tone.

2.34.3.13 Reapply the fail-safe enable pulse according to paragraph 2.34.3.3.

2.34.3.14 Lower the FTR input voltage to 0.5 volts below the minimum specified fail-safe voltage and measure the time from when the voltage is lowered to when a TERMINATE output occurs. Record the time as the *fail-safe low voltage time*.

2.34.3.15 Repeat paragraphs 2.34.3 through 2.34.3.14 using the maximum specified voltage and pulse width for the fail-safe enable pulse.

2.34.4 Pass/Fail Criteria. The fail-safe loss of tone time, loss of RF time, loss of power time, and fail-safe low voltage will meet the values in the specification. The TERMINATE output will not occur when fail-safe has not been enabled or the tone or RF are not lost for the minimum specified times.

2.34.5 Test Equipment Requirements. A second power supply capable of supplying the fail-safe enable voltages and a method of controlling the application of voltage to within one millisecond. An instrument is required to measure the delay between the application of RF or lowering the input voltage and the TERMINATE output.

Test No. 35

2.35 Tone Drop (Secure FTR)

2.35.1 Purpose. This test verifies that the **secure** FTR will not decode a secure command message that is missing a tone in one of the tone pairs. This test removes at least one tone in the secure command message. The secure command message format is shown in Figure S-1 in the IRIG Standard 313-01 Supplement (FOUO).

2.35.2 Requirement. The FTR will reject an otherwise valid command when one tone in the sequence has been dropped (RCC Document 319-99, Chapter 8, subparagraph 8.12.36).

2.35.3 Test.

2.35.3.1 Setup: Connect the unit to the test equipment as shown in Figure 1-2 and Table 2-35.

TABLE 2-35. TEST SETUP FOR TONE DROP (SECURE FTR)	
<u>Device</u>	<u>Settings</u>
RF Generator	
Power Output	-95 dBm
Frequency	F_o
Deviation	± 30 kHz/tone
Tone Generator	
	Secure commands are used
Power Supply	
Voltage	Nominal specified voltage

2.35.3.2 Load the test/maintenance code for the ARM command into the FTR. Send the ARM command and verify an ARM command output.

2.35.3.3 Configure the message encoder to drop one of the pair of tones in ARM message character one. All other parameters within the message are to remain at nominal, including the overall message length. Send the command and verify no command output.

2.35.3.4 Return message format to nominal and configure the message encoder to drop one of the pair of tones in ARM message character two. All other parameters with the message are to remain at nominal, including the overall message length. Send the command and verify no command output.

2.35.3.5 Repeat subparagraph 2.35.3.4 for each of the remaining 11 ARM message characters.

2.35.3.6 Send a valid test/maintenance ARM command and verify an ARM command output.

2.35.4 Pass/Fail Criteria. All commands with a tone dropped will be rejected by the FTR.

2.35.5 Test Equipment Requirements. The command message encoder must have the capability to drop (delete) one of the tone pairs in each of the 11-message characters while holding all other message parameters constant.

Test No. 36

2.36 Tone Balance (Secure FTR)

2.36.1 Purpose. This test measures the point where the amplitude imbalance between two tones within the same message character in the secure command message will cause the FTR to NOT decode an otherwise nominal command.

2.36.2 Requirement. The amount of tone pair imbalance, with the FTR continuing to process the command, will be within the component specification (RCC Document 319-99, Chapter 8, subparagraph 2.12.37). See Figure S-1, Secure command message format, in IRIG Standard 313-01 Supplement (FOUO).

2.36.3 Test.

2.36.3.1. Setup: Connect the unit to the test equipment as shown in Figure 1-2 and Table 2-36.

TABLE 2-36. TEST SETUP FOR TONE BALANCE (SECURE FTR)	
<u>Device</u>	<u>Settings</u>
RF Generator	
Power Output	-95 dBm
Frequency	F_o
Deviation	± 30 kHz/tone)
Tone Generator	
	Secure commands are used
Power Supply	
Voltage	Nominal specified voltage



The message encoder will be configured to decrease the amplitude of one tone in each of the pairs within each of the 11-message characters.

2.36.3.2 Load the test/maintenance code for the ARM command into the FTR.

2.36.3.3 Send the ARM command and verify an ARM command output.

2.36.3.4 Configure the message encoder to permit the amplitude of one of the pair of tones in the ARM message character one to be gradually decreased. All other parameters within the message are to remain at nominal. Send the command and verify an ARM command output.

2.36.3.5 While monitoring the ARM command output, slowly decrease the amplitude of one of the tones in character one until the ARM command output drops. Record the amplitude of the tone and which tone was decreased.

2.36.3.6 Return message amplitude setting to nominal and repeat subparagraphs 2.36.3.4 and 2.36.3.5 for one of the tones in each of the remaining ARM message characters.

2.36.3.7 Send a valid test/maintenance ARM command and verify an ARM command output.

2.36.4 Pass/Fail Criteria. The FTR will decode the command correctly when the tone pair imbalance is equal to the maximum specified.

2.36.5 Test Equipment Requirements. The command message encoder must have the capability to decrease the amplitude of one of the tone pairs in each of the 11-message characters while holding all other message parameters constant.

Test No. 37

2.37 Message Timing (Secure FTR)

2.37.1 Purpose. This test measures the **secure** FTR's ability to tolerate timing parameter errors in an otherwise nominal command of Character ON time, Character DEAD time, and Intermessage DEAD time.

2.37.2 Requirement. The FTR message timing tolerances will be within the component specification (RCC Document 319-99, Chapter 8, subparagraph 8.12.38).

2.37.3.1 Setup: Connect the unit to the test equipment as shown in Figure 1-2 and Table 2-37.

TABLE 2-37. TEST SETUP FOR MESSAGE TIMING (SECURE FTR)	
<u>Device</u>	<u>Settings</u>
RF Generator	
Power Output	-95 dBm
Frequency	F _o
Deviation	±30 kHz/tone
Tone Generator	
	Secure commands are used
Power Supply	
Voltage	Nominal specified voltage



The message encoder will be configured to vary the timing parameters one at a time while holding all other parameters, including overall message length, at nominal.

2.37.3.2 Load the test/maintenance code for the ARM command into the FTR.

2.37.3.3 Send the ARM command and verify an ARM command output.

2.37.3.4 Configure the message encoder to permit the timing of the ARM character one ON time to be gradually increased and then decreased. All other parameters within the message are to remain at their nominal setting.

2.37.3.5 While monitoring the ARM command output, slowly decrease the ON time of character one until the ARM command output drops out, and then increase it until ARM output is back on. Record the timing value as *ON-time minimum for character one*.

2.37.3.6 Reset the character ON time to nominal. Send the ARM command and verify an ARM command output.

2.37.3.7 While monitoring the ARM command output, slowly increase the ON time of character one until the ARM command output drops out and then decrease it until ARM output is back on. Record the timing value as *ON-time maximum for character one*.

2.37.3.8 Reset the character ON time to nominal. Send the ARM command and verify an ARM command output.

2.37.3.9 Repeat subparagraphs 2.37.3.5 through 2.37.3.8 for each one of the remaining ARM message characters.

2.37.3.10 Configure the message encoder to permit the time of the DEAD time between characters one and two in the ARM message to be gradually increased and then decreased. All other parameters within the message are to remain at nominal.

2.37.3.11 While monitoring the ARM command output, slowly decrease the DEAD time between characters one and two until the ARM command output drops and then increase it until the ARM output is back on. Record the time as the *DEAD-time minimum for character one*.

2.37.3.12 Reset the character DEAD time to nominal. Send the ARM command and verify an ARM command output.

2.37.3.13 While monitoring the ARM command output, slowly increase the DEAD time between characters one and two until the ARM command output drops and then decrease it until the ARM output is back on. Record the time as the *DEAD-time maximum for character one*.

2.37.3.14 Reset the character DEAD time to nominal. Send the ARM command and verify an ARM command output.

2.37.3.15 Repeat subparagraphs 2.37.3.11 through 2.37.3.14 for each one of the remaining ARM message DEAD times.

2.37.3.16 Configure the message encoder to permit the timing of the intermessage DEAD time to be gradually increased and then decreased. All other parameters within the message are to remain at nominal.

2.37.3.17 While monitoring the ARM command output, slowly decrease the intermessage DEAD time until the ARM command output drops and then increase it until the ARM output is back on. Record the time as the *intermessage-DEAD-time minimum*.

2.37.3.18 Reset the intermessage DEAD-time to nominal. Send the ARM command and verify an ARM command output.

2.37.3.19 While monitoring the ARM command output, slowly increase the intermessage DEAD time until the ARM command output drops out and then decrease it until the ARM output is back on. Record the time as the *intermessage-DEAD-time maximum*.

2.37.3.20 Reset the intermessage DEAD time to nominal. Send the ARM command and verify an ARM command output from the FTR.

2.37.4 Pass/Fail Criteria. The measured FTR message timing tolerances will be within the component specification.

2.37.5 Test Equipment Requirements. The command message encoder must have the capability to vary the intermessage DEAD time after the 11 message character while holding all other message parameters constant.

Test No. 38

2.38 DESTRUCT Before ARM (Secure FTR)

2.38.1 Purpose. This test verifies that a **secure** FTR will not decode a DESTRUCT command before decoding an ARM command.

2.38.2 Requirement. The FTR will reject an otherwise valid DESTRUCT command if not preceded by a valid ARM command (RCC Document 319-99, Chapter 8, subparagraph 8.12.39).

2.38.3 Test.

2.38.3.1 Setup: Connect the unit to the test equipment as shown in Figure 1-2 and Table 2-38.

TABLE 2-38. TEST SETUP FOR DESTRUCT BEFORE ARM (SECURE FTR)	
<u>Device</u>	<u>Settings</u>
RF Generator	
Power Output	-47 dBm
Frequency	F _o
Deviation	±30 kHz/tone
Tone Generator	
	Secure tones will be used
Power Supply	
Voltage	Nominal specified voltage

2.38.3.2 Apply the TERMINATE command without preceding it with the ARM command. Verify that the FTR does not produce an output. If the FTR microprocessor contains any alarm outputs indicating an illegal command, verify and record these outputs.

2.38.3.3 This test should be included as part of test in subparagraph 2.32.2.

2.38.4 Pass/Fail Criteria. The FTR will process the commands properly and will not have any undesired output, either on a monitor or a command output channel.

2.38.5 Test Equipment Requirements. All FTR outputs for telemetry monitoring and command outputs must be continuously monitored during this test.

Test No. 39

2.39 Reset (Secure FTR)

2.39.1 Purpose. This test verifies that the **secure** FTR will reset all latched outputs by resetting of the dc power input to off then back on or after the decoding of a proper RESET command.

2.39.2 Requirement. The FTR will remove all outputs by dc power cycling (ON/OFF/ON) and by processing a valid secure reset command (RCC Document 319-99, Chapter 8, subparagraph 8.12.41).

2.39.3 Test.

2.39.3.1 Setup: Connect the unit to the test equipment as shown in Figure 1-2 and Table 2-39.

TABLE 2-39. TEST SETUP FOR RESET (SECURE FTR)	
<u>Device</u>	<u>Settings</u>
RF Generator	
Power Output	-47 dBm
Frequency	F _o
Deviation	±30 kHz/tone
Tone Generator	
	Secure tones will be used
Power Supply	
Voltage	Nominal specified voltage

2.39.3.2 Apply an ARM command. Verify that the FTR has the appropriate outputs. Switch dc power to the FTR OFF, remove the command from the FTR input, and then switch power ON. Verify that the FTR no longer has ARM command or command monitoring outputs.

2.39.3.3 Apply an ARM and then a TERMINATE command. Verify that the FTR has the appropriate outputs. Switch dc power to the FTR OFF, remove the command from the FTR input, and then switch power ON. Verify that the FTR no longer has any command or command monitoring outputs.

2.39.3.4 If the FTR is capable of decoding an RF RESET command, repeat the test except substitute the RF RESET command for turning the dc power to the FTR OFF and then ON as in paragraphs 2.39.3.2 and 2.39.3.3.

2.39.3.5 Repeat the test for all latched commands that the FTR is capable of decoding.

2.39.4 Pass/Fail Criteria. The FTR will process the commands properly and will not have any undesired output, whether on a monitor or command output channel.

2.39.5 Test Equipment Requirements. All FTR outputs for latched commands must be continuously monitored during this test.

Test No. 40

2.40 Memory (Secure FTR)

2.40.1 Purpose. This test verifies that the **secure** FTR memory is retained and is usable following periods of time when no primary dc voltage has been applied. With approval of the LRSO, this test may be accomplished at the board level, and later, on a production unit.

2.40.2 Requirement. The secure commands will remain in memory for the specified time interval (RCC Document 319-99, Chapter 8, subparagraph 8.12.42).

2.40.3 Test.

2.40.3.1 Setup: Connect the unit to the test equipment as shown in Figure 1-2 and Table 2-40.

TABLE 2-40. TEST SETUP FOR MEMORY (SECURE FTR)	
<u>Device</u>	<u>Settings</u>
RF Generator	
Power Output	-95 dBm
Frequency	F_o
Deviation	± 30 kHz/tone
Tone Generator	
	Secure commands are used
Power Supply	
Voltage	Nominal specified voltage

2.40.3.2 Load test/maintenance codes into the FTR for each command the FTR is specified to decode.

2.40.3.3 Verify the loading of the code by performing a logic test per the appropriate portion of paragraph 2.32.

2.40.3.4 Remove the primary dc voltage to the FTR for 90 days or as specified by the procurement specification.

2.40.3.5 After the waiting time specified has been met per subparagraph 2.40.3.4, again perform the logic test per paragraph 2.32.

2.40.4 Pass/Fail Criteria. The FTR will retain the stored codes for the specified time and properly decode the commands after the power is reapplied after being removed for the specified time.

2.40.5 Test Equipment Requirements. No special requirements.

Test No. 41

2.41 Electromagnetic Interference (EMI)/Electromagnetic Compatibility (EMC)

2.41.1 Purpose. This test ensures that the FTR is in compliance with the requirements of MIL-STD-461, *Requirements for the Control of Electromagnetic Interference Characteristics of Subsystems and Equipment*.

2.41.2 Requirement. The FTR will meet the requirements of the component specification (RCC Document 319-99, Chapter 8, subparagraph 8.12.44).

2.41.3 Test.

2.41.3.1 Setup: As directed by measurement procedures in MIL-STD-461. The EMI/EMC test will be conducted in accordance with the latest revision of MIL-STD-461.

2.41.4 Pass/Fail Criteria. The FTR will meet the requirements of the component specification.

2.41.5 Test Equipment Requirements. The test equipment requirements are contained in MIL-STD-461. In addition, test equipment is required to measure and record the operability of the FTR during this test.

GLOSSARY

ACCEPTANCE TESTING

Required formal tests conducted to demonstrate acceptability of the unit for delivery. These tests demonstrate performance to purchase specification requirements and act as quality control screens to detect deficiencies in workmanship and materials. The successful completion of such tests denotes acceptance of the unit by the procurement agency.

BANDWIDTH

The range of frequencies in which performance of an FTR is within specified limits.

BREAK-OUT-BOX (BOB)

A piece of test equipment used to gain access to the various input and output pins on the connectors of the unit under test.

CAPTURE RATIO

The capacity of an FTR to receive and execute a command when an interfering continuous-wave (CW) carrier is simultaneously input to the FTR. The CW signal is increased to the point where it captures the FTR. The capture ratio is the ratio of the desired signal strength to the interfering signal strength at the time of capture.

CERTIFICATION TESTING

A laboratory-controlled environment test where the unit is verified to comply with design specifications. This test is usually a subset to the acceptance test and certifies the unit for flight use. It has a specified certification period (in days) whereby, if the unit is not flown within that specified time, it must be recertified.

CW BANDWIDTH

The FTR CW response at assigned center frequency versus response above and below assigned carrier frequency when the RF input level is increased 60 dB from threshold.

DECIBEL (dB)

A unit of relative power. The decibel ratio between two power levels, P1 and P2, as defined by the relation $\text{dB} = 10 \log_{10} (P1/P2)$.

dBm

A unit used to express an arbitrary power level in terms of its decibel ratio to a reference level of one milliwatt.

DECODER

A device that will distinguish between the different RCC tones present in a discriminated composite audio signal and is capable of performing logic analysis based on the combination or lack of tones present.

DECODER ABNORMAL/NORMAL LOGIC

An FTR is subjected to standard RCC tones in various combinations and sequences to determine whether the FTR responds in the prescribed manner. Some tone combinations produce FTR outputs (normal logic) and some should not (abnormal logic).

DEVELOPMENT TESTING

These tests validate hardware design concepts and assist in the evolution of designs from the conceptual to the operational phase. The objective is to identify hardware problems early in their design evolution, so that any required actions can be taken prior to the beginning of formal qualification testing and production fabrication.

DEVIATION

- a) A noncompliance to RCC STD 319. A deviation does not comply with or meet the intent of the written requirement, but it also does not introduce any significant safety risk.
- b) A departure from a prescribed specification.
- c) See Modulation.

DEVIATION COMPATIBILITY

The ability of an FTR to reject commands that are within encoder tone frequency limits when the carrier is modulated with 9 kHz or less deviation.

DEVIATION SENSITIVITY

The amount of FM deviation required to cause an FTR to correctly execute a command.

FAIL-SAFE

A method built into flight termination systems that will activate an output upon the loss of power and/or RF signal and/or tone.

FAIL SAFE BYPASS

A method used to enable or disable the fail-safe; usually referred to when the fail-safe is disabled.

FAST FOURIER TRANSFORM

A Fourier transform that employs the Cooley-Tukey algorithm to reduce the number of operations.

FLIGHT TERMINATION

The process whereby an airborne vehicle's flight trajectory is stopped. Flight termination does not imply a method of achieving termination.

FLIGHT TERMINATION RECEIVER

A generic term used to define the RF radio receiver/decoder employed on flight vehicles to receive ground encoded commands.

FLIGHT TERMINATION SYSTEM

The entire system on an airborne vehicle used to receive, decode, and execute the ground signals. It includes all wiring, power systems, and methods or devices used to terminate flight.

INTERRANGE INSTRUMENTATION GROUP (IRIG)

Original standing groups formed by the Range Commanders Council. The IRIG is an older term that has been replaced by individual standing groups such as the Range Safety Group (RSG).

MAXIMUM USABLE RF INPUT

The capacity of an FTR to properly respond to commands after being subjected to high RF input of a specified level. Also known as *blocking*.

MEETS INTENT COMPLIANCE

When a design does not meet the exact RCC STD 319 requirement, but it does meet the intent of the requirement.

MODULATION

The process by which an RF carrier is varied in accordance with a modulation wave/signal. In the case of an FTR, frequency modulation (FM) is employed. In FM the carrier is shifted about the assigned frequency at an interval equal to the modulation tone frequency (RCC tone) or the

RMS sum of the tones when more than one tone is used. The distance that the carrier is shifted is equal to the amplitude of the modulation tone or the rms sum of all the tones.

Example: The tone frequency is 8.00 kHz and the amount of deviation is 30 kHz. The carrier is shifting at a rate of 8.00 kHz and a distance of 30 kHz.

NOMINAL SENSITIVITY

The minimum specified RF input level to the FTR (when properly modulated) that must produce the desired outputs. Also known as the "factory-guaranteed" sensitivity level. The nominal level is that level specified as the minimum in the procurement specification. It is not the actual measured level.

NONSTANDARD RCC TONES (Secure FTR Tones)

The unique set of tone frequencies used for secure receivers.

OPERATING FREQUENCY

The RF center frequency (F_o) in a CW mode that has been assigned by the procurement specification. Also referred to as the *assigned frequency*.

OPERATIONAL BANDWIDTH

The overall range of frequencies, plus and minus added together, and representing the amount that a properly modulated signal operating frequency can be varied, and the limits within which an FTR will continue to properly receive and decode a signal.

POWER DIVIDER/SPLITTER

Used to divide RF input power to more than two output ports. Dividers are available that have multiple input ports and multiple output ports and are commonly used to distribute the output of the antennas to the input of the FTRs. They provide attenuation to the signal in the form of both insertion and coupling losses. Also referred to as *couplers*.

PRIMARY BATTERY

A battery not intended to be recharged that is disposed of in controlled conditions when it has delivered all its electrical energy.

QUALIFICATION TESTING

The testing of a device or component to demonstrate that the design, manufacturing, and assembly processes have resulted in hardware and software that conform to the specification.

QUIESCENT LEVEL

A condition of a circuit element which has no input signal so that it does not perform its active function.

RANGE PRELAUNCH TESTING

These tests involve component-level and system-level testing procedures.

RCC TONES

A group of 20 standard tone frequencies used in non-secure receivers and that are specified in RCC Document 313 Supplement, *Test Standards for Flight Termination Receivers/Decoders Supplement (For Official Use Only)*.

REDUNDANCY

Two or more components, circuits, assemblies, or systems that serve the same objective.

RESISTANCE AND ISOLATION

The resistance between FTR terminals that are common (resistance) and those that are not common (isolation).

RESPONSE TIME

The period of time from reception of a command signal at an FTR until the time of an output.

RF CENTER FREQUENCY

The frequency to which the receiver is tuned. The frequency halfway between the cut-off frequencies of the receiver.

RF LEVEL MONITOR

Same as signal strength telemetry output.

SIGNAL STRENGTH TELEMETRY OUTPUT (SSTO)

A voltage that is directly proportional to the amount of RF signal the FTR is receiving. The FTR uses its automatic gain control (AGC) voltage as the basis for SSTO voltage. This output signal is usually scaled from 0 to 5 Vdc and is also commonly referred to as *AGC* or *signal strength telemetry (SST)*. The preferred acronym is SSTO.

STANDARD RCC TONES

See RCC Tones

TELEMETRY

Measurement of data with the aid of a transmission medium that permits measurements to be interpreted at a distance from the detector. The telemetry system is used for range safety system real-time status reporting.

TERMINATE COMMAND

A command which, when received and decoded, will cease the flight profile of an airborne vehicle.

THRESHOLD SENSITIVITY

The actual measured minimum RF, properly modulated, required to produce a desired output from an FTR. This sensitivity is different from the nominal sensitivity and is usually a lower RF level. Also referred to as *RF threshold* and *command threshold*.

TRANSITION TIME

The time required for an FTR to transition from an ARM output to a TERMINATE output.

VOLTAGE STANDING WAVE RATIO (VSWR)

The ratio of the magnitude of the transverse electric field in a plane of maximum strength to the magnitude at the equivalent point in an adjacent plane of minimum field strength.

In a perfect system, all transferred energy is accepted and coupled to the next device/system. Any unaccepted/coupled energy is reflected back to the originating device/system. Perfect VSWR is 1:1.

WAIVER

Granted use or acceptance of an article that does not meet the specified requirement.

SIGNAL STRENGTH TELEMETRY OUTPUT (SSTO) CURVE

A voltage plot of the FTRs signal strength monitor voltage versus RF input signal strength.

INDEX

abnormal voltage	10, 16	image frequency rejection.....	54, 55
test setup	16	image response rejection.....	11, 53
acceptance testing	90	test setup	53
adjacent channel rejection.....	<i>See</i> channel rejection	input current and voltage	10, 20
AM rejection.....	11, 60	test setup	20
amplitude modulation		input impedance.....	10, 28
test setup	60	test setup	28
audio output	11, 76	Interrange Instrumentation Group	8, 80, 81, 92
test setup	76	leakage current.....	10, 27, 28
capture ratio	11, 57, 90	test setup	27
certification testing	90	logic	91
channel rejection.....	11	letter convention	8
test setup	51	secure logic	11
command FTR outputs	8	sequence of tones	8
command response time	11, 94	standard command	8
test setup	62	logic sequence	8
continuous wave (CW) bandwidth		maximum usable RF input.....	92
test setup	38	maximum usable RF level	10, 33
continuous wave bandwidth	<i>See</i> CW bandwidth	test setup	33
continuous wave peak-to-valley ratio	<i>See</i> CW peak-to-valley ratio	memory.....	11, 87
CW bandwidth.....	10, 90	test setup	87
CW peak-to-valley ratio	10, 42, 43	message timing	11, 83
decibel	90	test setup	83
decoder channel bandwidth	10, 45, 46, 47, 48	minimum RF level	93
test setup	45	modulation.....	7, 92
decoder channel deviation	11, 49	noise immunity	11, 69
test setup	49	test setup	69
decoder logic	11	nominal sensitivity level	<i>See</i> minimum RF level
DESTRUCT Before ARM.....	11, 85	nonstandard RCC tone	93
test setup	85	nonstandard RCC tones	<i>See also</i> secure FTR tones
deviation	50, 91	operating frequency	<i>See</i> RF center frequency
dynamic stability.....	11, 65	operational bandwidth	10, 40, 41, 93
test setup	65	test setup	40
electromagnetic compatibility	11, 89	out-of-band rejection	11, 68
test setup	89	test setup	68
electromagnetic interference.....	11, 89	output circuit protection.....	10, 14
test setup	89	test setup	14
fail safe	11, 78	output functions	10, 32
test setup	78	test setup	32
fail-safe	78, 79, 91, 92	output load characteristics	11, 63
failure report	2, 3, 4	test setup	63
fast Fourier transform	47, 48, 92	overvoltage protection	7, 10, 18
flight termination	3, 10, 92	test setup	18
FTR test matrix.....	10, 11	peak-to-valley ratio	
FTR command outputs	8	test setup	42
FTR input current	7	power (dc) cycling	
FTR input dc voltage	7	test setup	24
FTR test equipment setup	5	power cycling	10, 24
hard failures	2	power transfer switch.....	10, 22
humidity.....	7	test setup	22
image frequency	55	qualification testing	93
		quiescent level	94

quieting sensitivity.....	11, 66	standard test parameters.....	7
test setup	66	stimulus signal	8
quiscent level	94	telemetry	95
RCC tone frequency	7	telemetry short circuit.....	10, 13, 65
RCC tones.....	93, 94, 95	test setup	13
reset (secure FTR)	11	temperature	5, 7, 11
test setup	86	test conditions	5
resistance	10, 19	testing procedures	
test setup	19	equipment setup	5
reverse polarity protection	10	FTR test matrix	10
RF center frequency.....	7, 38, 40, 93	humidity	7
RF input level	7, 90, 93	input current.....	7
RF level monitor.....	10, 35	modulation	7
test setup	35	RF center frequency.....	7
RF threshold sensitivity 7, 9, 10, 31, 32-37, 39, 41, 95		RF input level	7
minimum RF level	9	sequence.....	9
test setup	31	standard test parameters	7
secure decoder bandwidth.....	10	temperature	5, 7
secure FTR pilot tone bandwidth		test conditions	5
test setup	47	timing.....	7
secure FTR tones	8, 93	warm-up time.....	5
secure logic	11, 72	tone balance	7, 11, 81
self test.....	10, 25, 26	test setup	81
self -test		tone distortion.....	7
test setup	25	tone drop.....	11, 80
signal strength telemetry output.... SSTO) 10, 14, 15,		test setup	80
31, 35-43, 54, 55, 58, 65, 69, 94, 95		tones	
soft failures	2	RCC tone frequency.....	7
spurious response rejection.....	53	secure FTR tones	8
test setup	53	standard.....	95
stable output.....	9	standard RCC tones	8, 63, 74, 75
standard channel bandwidth		tone balance	7
test setup	45	tone distortion	7
standard command logic	8	tone drop	11
standard decoder bandwidth	10	transition time	95
standard logic.....	11, 71	voltage standing wave ratio	95
standard logic verification test.....	74, 75	waiver	95
standard RCC tones	8	warm-up time.....	5, 12
standard test parameter	7	test setup	12